



# SmarterGlass

state-of-the-art display solutions

[www.smarterglass.com](http://www.smarterglass.com)  
978 465 6190  
[sales@smarterglass.com](mailto:sales@smarterglass.com)

**DLC Display Co., Limited**

德爾西顯示器有限公司



MODEL No: DLC1010CIG-T-10

TEL: 86-755-86029824

FAX: 86-755-86029827

E-MAIL: [sales@dlcdisplay.com](mailto:sales@dlcdisplay.com)

WEB: [www.dlcdisplay.com](http://www.dlcdisplay.com)

### Record of Revision

Date	Revision No.	Summary
2015 10 29	1.0	Rev 1.0 was issued

## 1. Scope

This data sheet is to introduce the specification of DLC1010CIG-T-10 active matrix TFT module. It is composed of a color TFT-LCD panel, driver ICs, FPC, capacitive touch panel and a backlight unit. The 10.1" display area contains 1280X3(RGB) x 800 pixels.

## 2. Application

Digital equipments which need color display, mobile navigator/video systems, tablet PC.

## 3. General Information

Item	Contents	Unit
Size	10.1	inch
Resolution	1280 x RGB x 800	/
Interface	Digital	/
Technology type	IPS TFT	/
Pixel pitch	0.0565x0.0565	mm
Pixel Configuration	RGB stripes	
Outline Dimension (W x H x D)	254.96x172.60x5.00	mm
Active Area	216.96x 135.60	mm
Display Mode	Transmissive, Normally Black	/
Backlight Type	LED	/
Weight	TBD	g

### 4. Outline Drawing

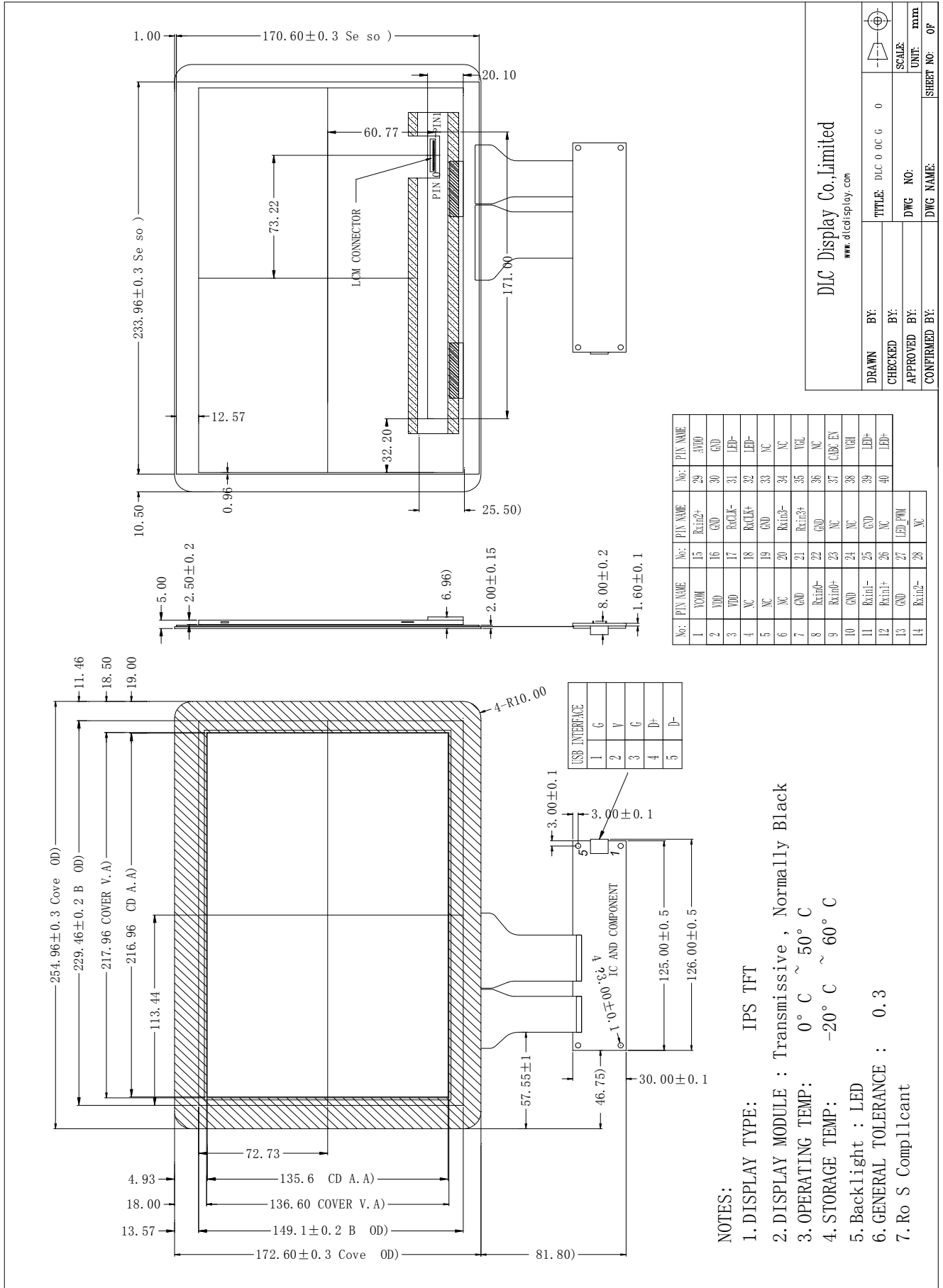

## 5. Interface signals

Pin No.	Symbol	I/O	Function	Remark
1	VCOM	P	Common Voltage	
2	VDD	P	Power Supply	
3	VDD	P	Power Supply	
4	NC	---	No connection	
5	NC	---	No connection	
6	NC	---	No connection	
7	GND	P	Ground	
8	Rxin0-	I	-LVDS Differential Data Input	R0-R5, G0
9	Rxin0+	I	+LVDS Differential Data Input	
10	GND	P	Ground	
11	Rxin1-	I	-LVDS Differential Data Input	G1~G5, B0,B1
12	Rxin1+	I	+LVDS Differential Data Input	
13	GND	P	Ground	
14	Rxin2-	I	-LVDS Differential Data Input	B2-B5,HS,VS, DE
15	Rxin2+	I	+LVDS Differential Data Input	
16	GND	P	Ground	
17	RxCLK-	I	-LVDS Differential Clock Input	LVDS CLK
18	RxCLK+	I	+LVDS Differential Clock Input	
19	GND	P	Ground	
20	Rxin3-	I	-LVDS Differential Data Input	R6, R7, G6, G7, B6, B7
21	Rxin3+	I	+LVDS Differential Data Input	
22	GND	P	Ground	
23	NC	---	No connection	
24	NC	---	No connection	
25	GND	P	Ground	
26	NC	---	No connection	
27	LED_PWM	O	CABC controller signal output for backlight	Note2
28	NC	---	No connection	
29	AVDD	P	Power for Analog Circuit	
30	GND	P	Ground	
31	LED-	P	LED Cathode	
32	LED-	P	LED Cathode	
33	NC	---	No connection	
34	NC	---	No connection	
35	VGL	P	Gate OFF Voltage	
36	NC	---	No connection	
37	CABC_EN	I	CABC Enable Input	Note1
38	VGH	P	Gate ON Voltage	
39	LED+	P	LED Anode	
40	LED+	P	LED Anode	

Connector: F62240-H1210A

Note 1: The settings of CABC function are as follows.

Pin	Enable	Disable
CABC_EN	High Voltage	Low Voltage or open

Note 2: LED\_PWM is used to adjust backlight brightness.

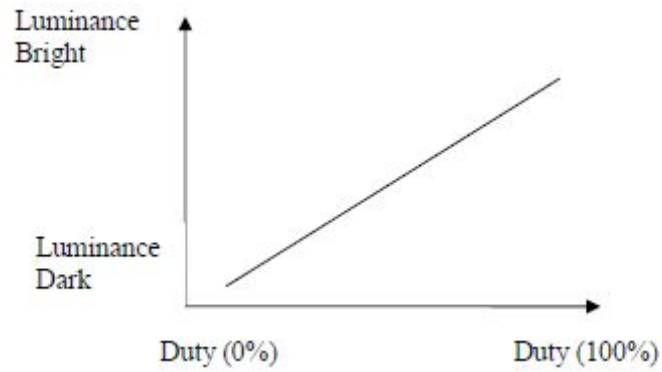

## 6. Absolute maximum Ratings

### 6.1. Electrical Absolute max. ratings

Parameter	Symbol	MIN	MAX	Unit	Remark
Power Voltage	VDD	-0.3	3.9	V	VSS=0V TA=25°C
	AVDD	-0.3	14.0	V	
	VGH	-0.3	42.0	V	
	VGL	-19	0.3	V	
	VGH-VGL	12	40.0	V	

### 6.2. Environment Conditions

Item	Symbol	MIN	MAX	Unit	Remark
Operating Temperature	TOPR	0	50	°C	
Storage Temperature	TSTG	-20	60	°C	

## 7. Electrical Specifications

### 7.1 Electrical characteristics

GND=0V, Ta=25°C

Item	Symbol	MIN	TYP	MAX	Unit	Remark
Power Voltage	VDD	2.3	2.5	2.7	V	
	AVDD	8.0	8.2	8.4	V	
	VGH	21.7	22	22.3	V	
	VGL	-7.3	-7	-6.7	V	
Input Logic Voltage	VIL	0	--	0.2DVDD	V	Note 2
	VIH	0.8VDD	--	VDD	V	
Input signal voltage	VCOM	3.0	3.3	3.6	V	Note 3

Note 1: Be sure to apply VDD and VGL to the LCD first, and then apply VGH.

Note 2: VDD setting should match the signals output voltage (refer to Note 3) of customer's system board.

Note 3: Typical VCOM is only a reference value, it must be optimized according to each LCM. Be sure to use VR.



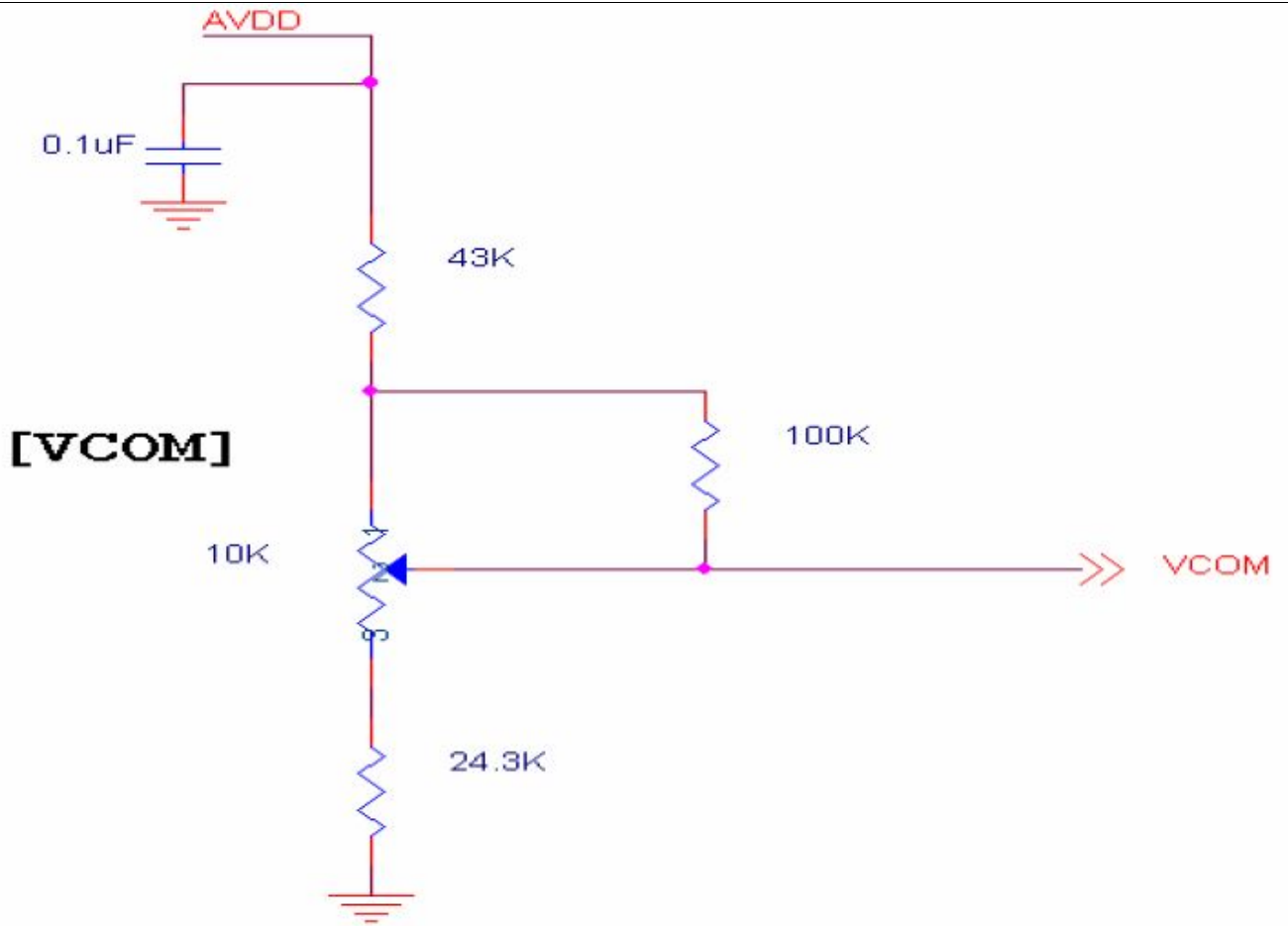

7.2 LED Backlight

Ta=25°C

Item	Symbol	MIN	TYP	MAX	Unit	Remark
Forward Current	IF	180	200	220	mA	
Forward Voltage	VF	8.7	9.3	9.9	V	Note 1

Note 1: The LED Supply Voltage is defined by the number of LED at Ta=25°C and IL =200mA.

## 8. Command/AC Timing

### 8.1 AC Electrical Characteristics

Parameter	Symbol	Values			Unit	Remark
		Min.	Typ.	Max.		
LVDS Differential input high Threshold voltage	RxVTH	-	-	+100	mV	RXVCM=1.2V
LVDS Differential input low Threshold voltage	RxVTL	-100	-	-	mV	
LVDS Differential input common mode voltage	RxVCM	0.7	-	1.6	V	
LVDS Differential voltage	VID	100	-	600	mV	

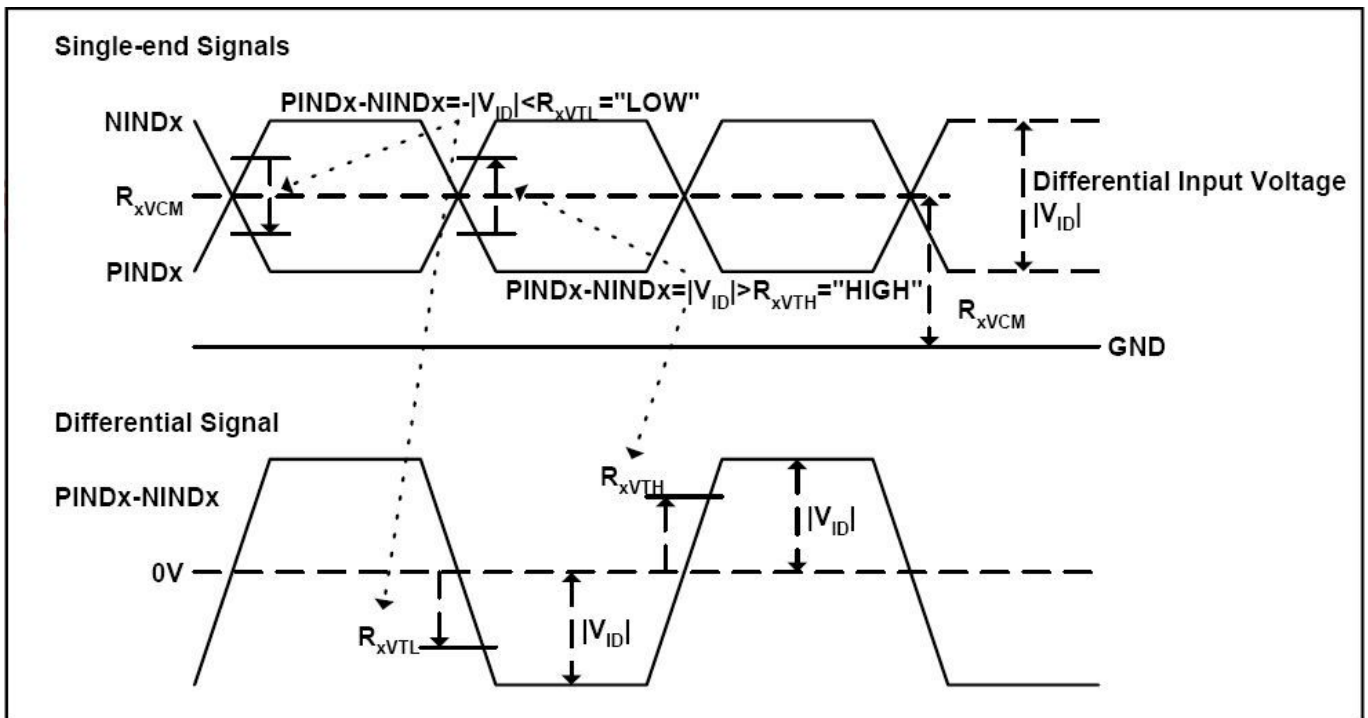

### 8.2 Timing Table

Item	Symbol	Values			Unit	Remark
		Min.	Typ.	Max.		
Clock Frequency	1/Tc	(68.9)	71.1	(73.4)	MHz	Frame rate =60Hz
Horizontal display area	tHD	1280			Tc	
HS period time	tH	(1410)	(1440)	(1470)	Tc	
HS Width +Back Porch +Front Porch	tHW+ tHBP +tHFP	(60)	(160)	(190)	Tc	
Vertical display area	tVD	800			tH	
VS period time	tv	(815)	(823)	(833)	tH	
VS Width +Back Porch +Front Porch	tvW+ tvBP +tvFP	(15)	23	(33)	tH	

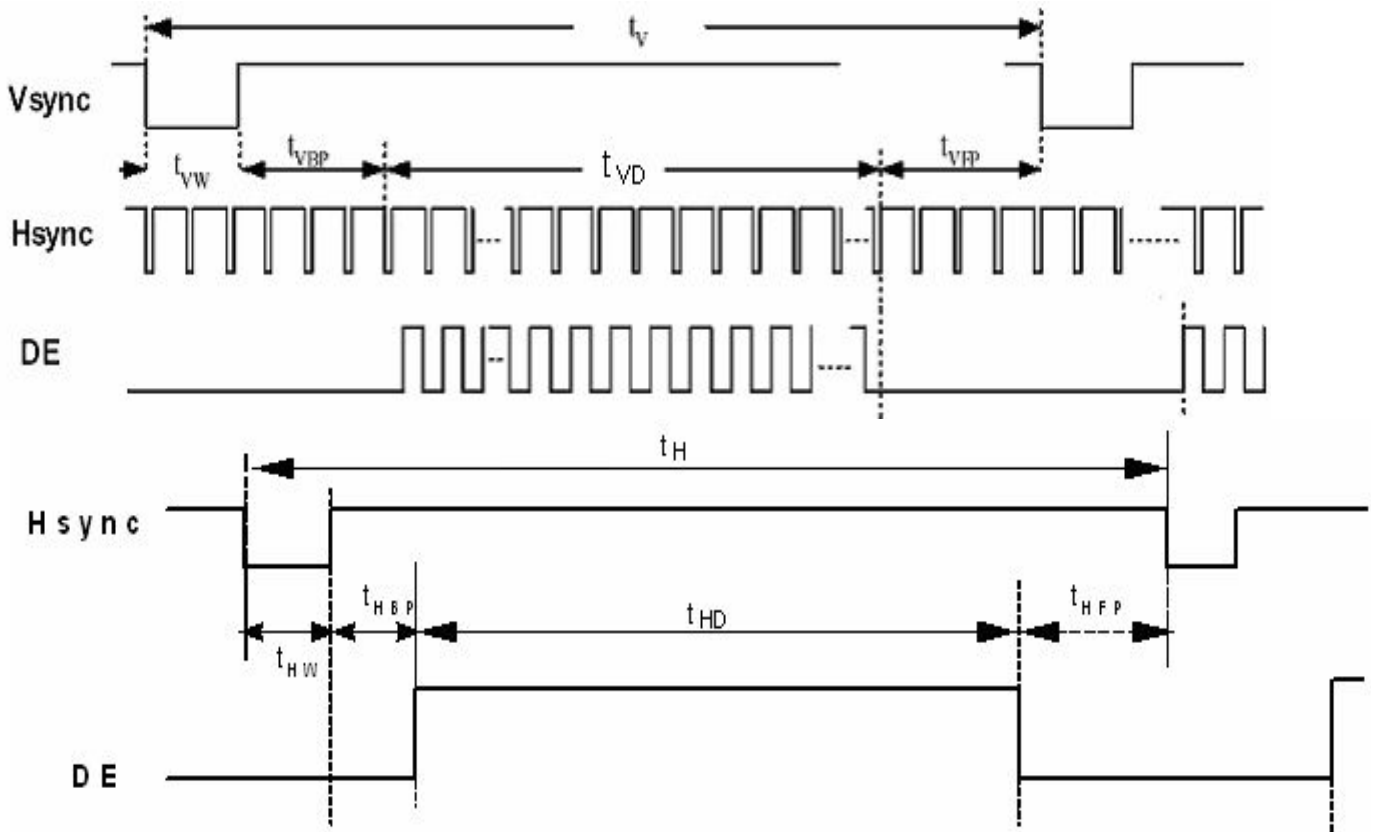

### 8.3 LVDS Data Input Format

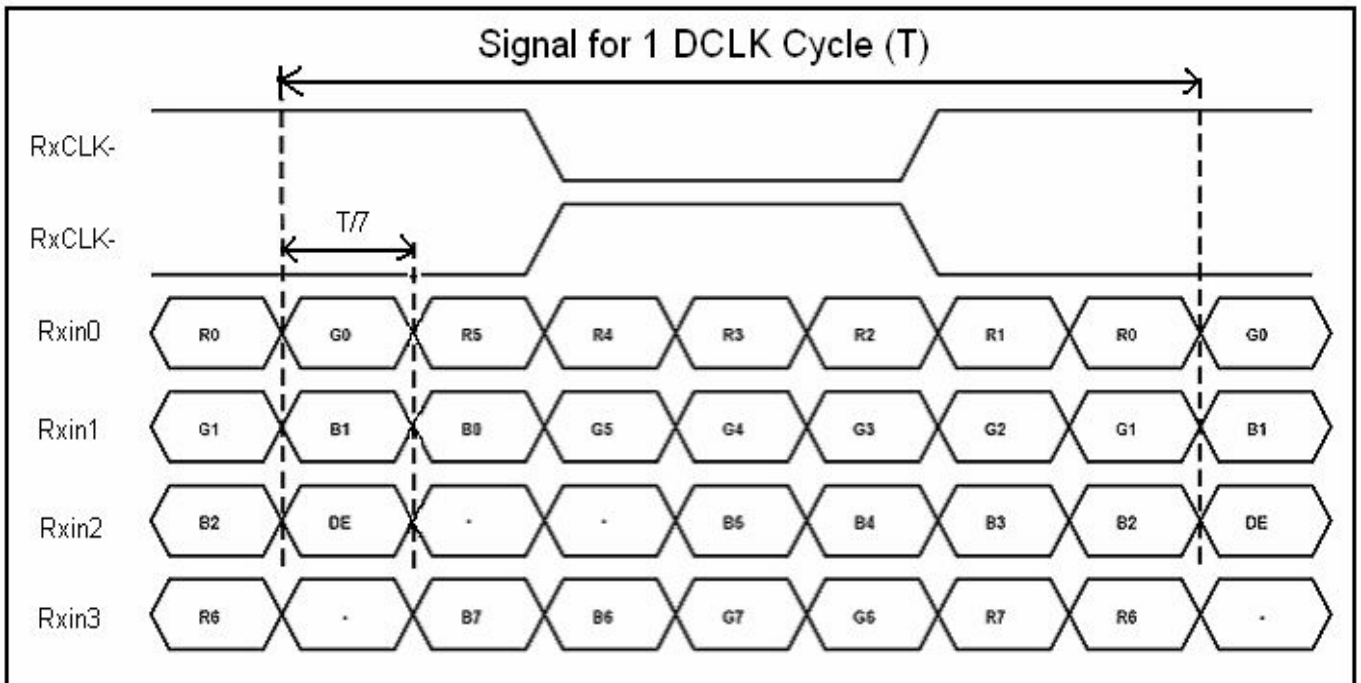

### 8.4 Power Sequence

#### 8.4.1 Power on:

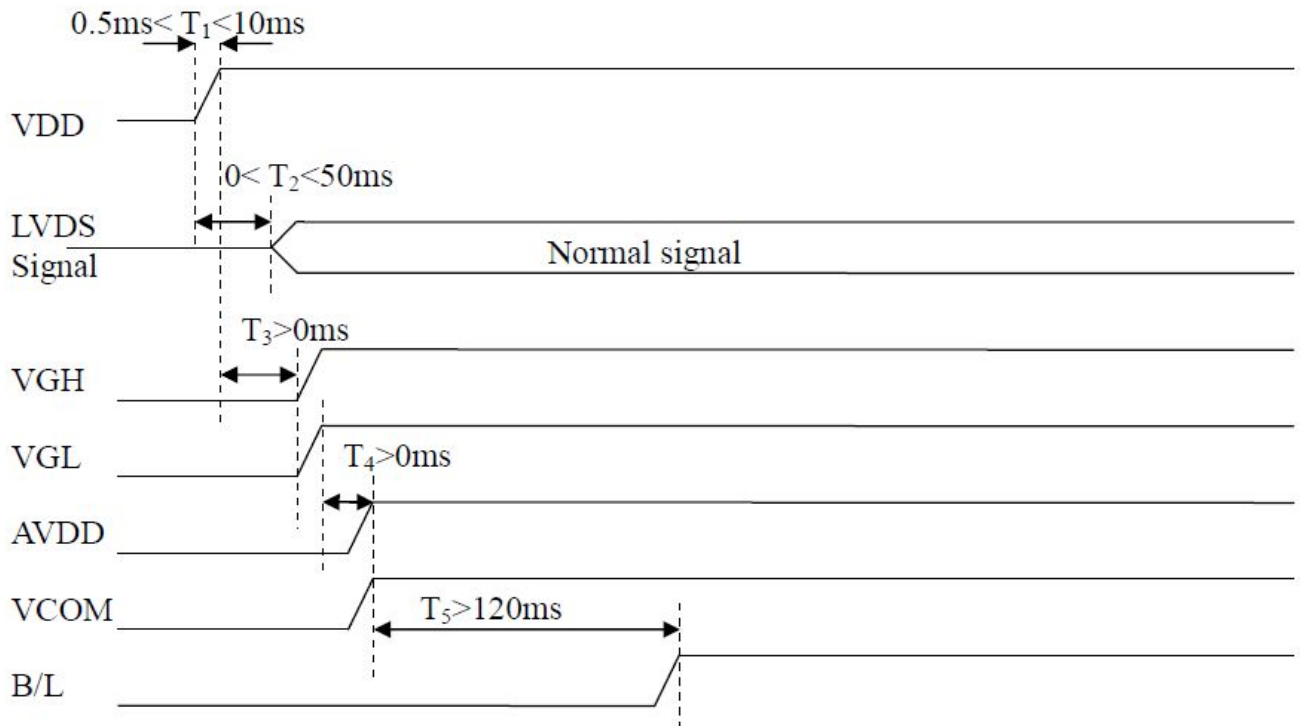

#### 8.4.2 Power off:

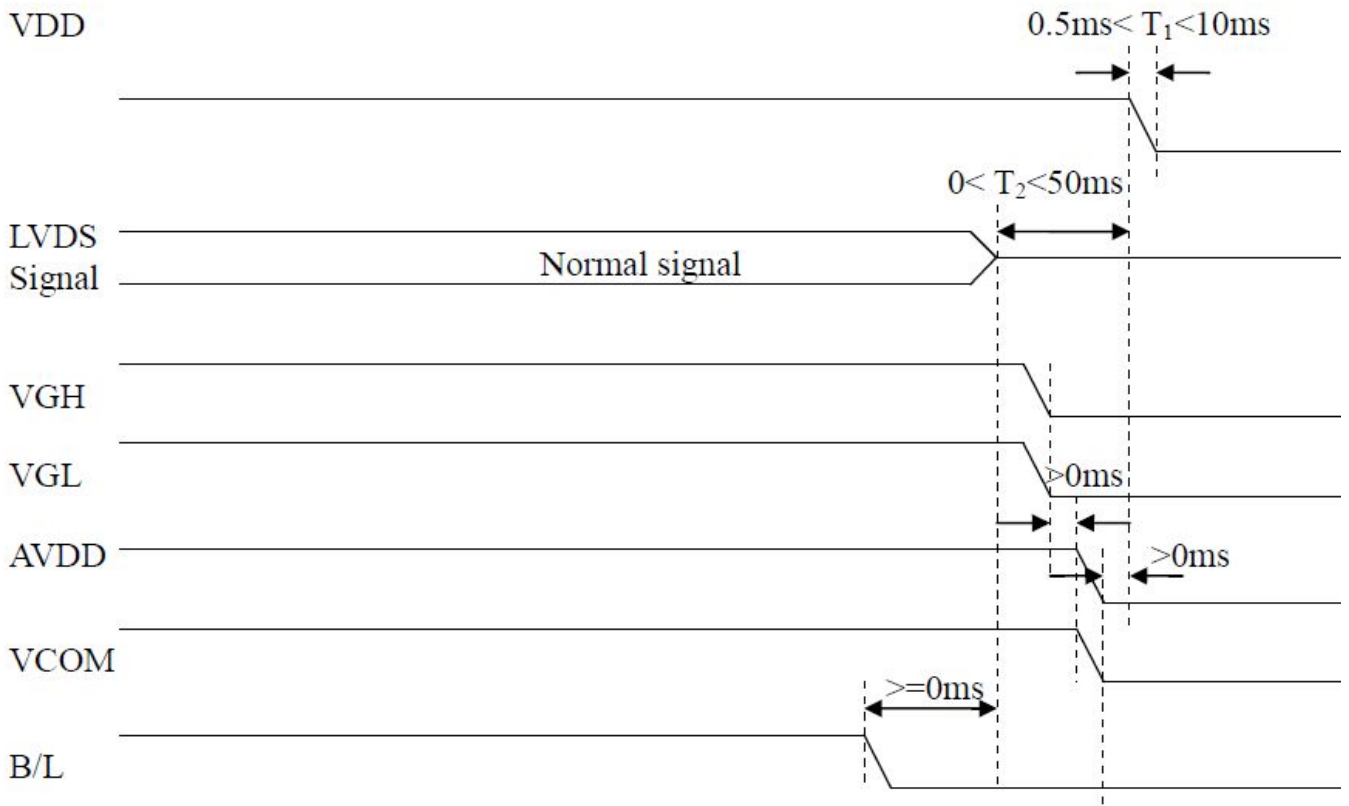

## 9. Optical Specification

Ta=25°C

Item	Symbol	Condition	Min	Typ.	Max.	Unit	Remark
Contrast Ratio	CR	$\theta=0^\circ$	600	800			Note1 Note2
Response Time	Tr	25°C		10	20	ms	Note1 Note3
	Tf			15	30		
View Angles	$\theta T$	$CR \geq 10$	75	85		Degree	Note 4
	$\theta B$		75	85			
	$\theta L$		75	85			
	$\theta R$		75	85			
Chromaticity	White	x	Brightness is on	0.26	0.31	0.36	Note5, Note1
		y		0.28	.33	0.38	
Luminance	L		190	230		cd/m <sup>2</sup>	Note1 Note6
Uniformity	U		70	75		%	Note1 Note7

Test conditions: VDD=3.3V, IL=200mA (Backlight current), the ambient temperature is 25°C. **Note 1:** Definition of optical measurement system.

Temperature = 25°C(±3°C)

LED back-light: ON, Environment brightness < 150 lx

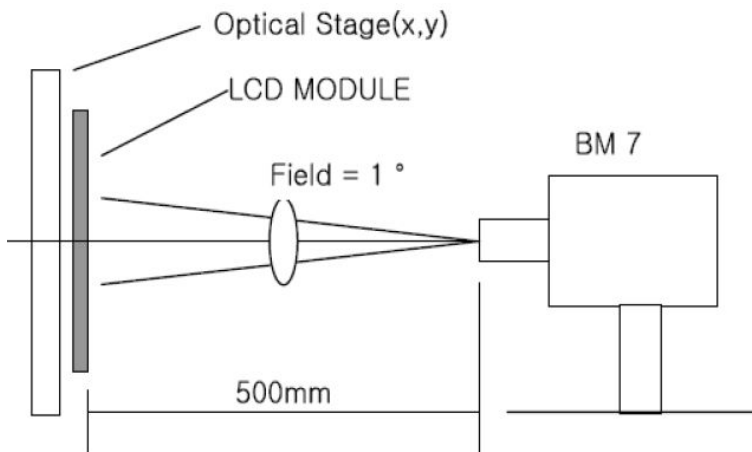

**Note 2:** Contrast ratio is defined as follow:

$$\text{Contrast Ratio} = \frac{\text{Surface Luminance with all white pixels}}{\text{Surface Luminance with all black pixels}}$$

Note 3: Response time is defined as follow:

Response time is the time required for the display to transition from black to white (Rise Time,  $T_r$ ) and from white to black (Decay Time,  $T_f$ ).

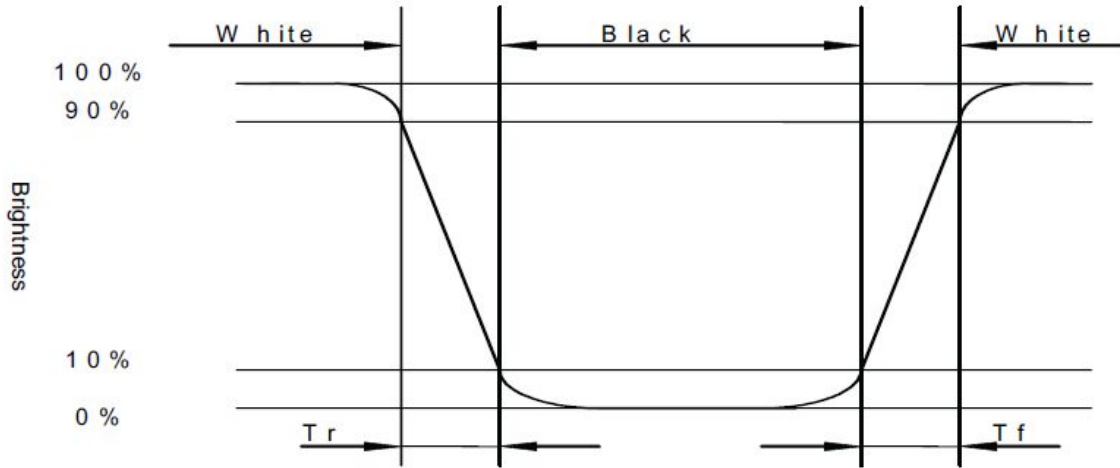

Note 4: Viewing angle range is defined as follow:

Viewing angle is measured at the center point of the LCD.

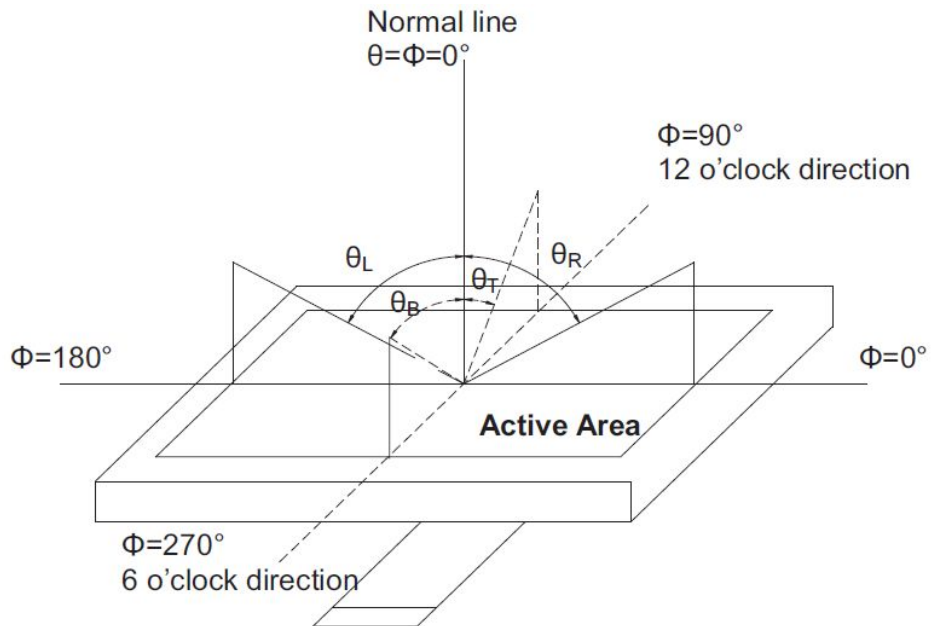

Note 5: Color chromaticity is defined as follow: (CIE1931)

Color coordinates measured at center point of LCD.

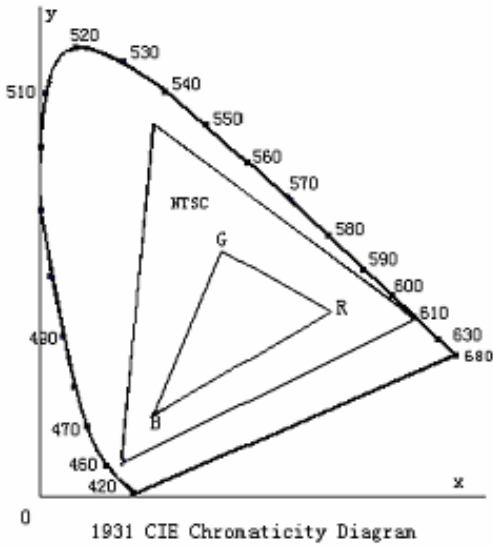

$$S = \frac{\text{area of RGB triangle}}{\text{area of NTSC triangle}} \times 100\%$$

Note 6: Luminance is defined as follow:

Luminance is defined as the brightness of all pixels “White” at the center of display area on optimum contrast.

Note 7: Luminance Uniformity is defined as follow:

Active area is divided into 9 measuring areas (Refer Fig. 2). Every measuring point is placed at the center of each measuring area.

$$\text{Uniformity (U)} = \frac{\text{Minimum Luminance( brightness ) in 9 points}}{\text{Maximum Luminance( brightness ) in 9 points}}$$

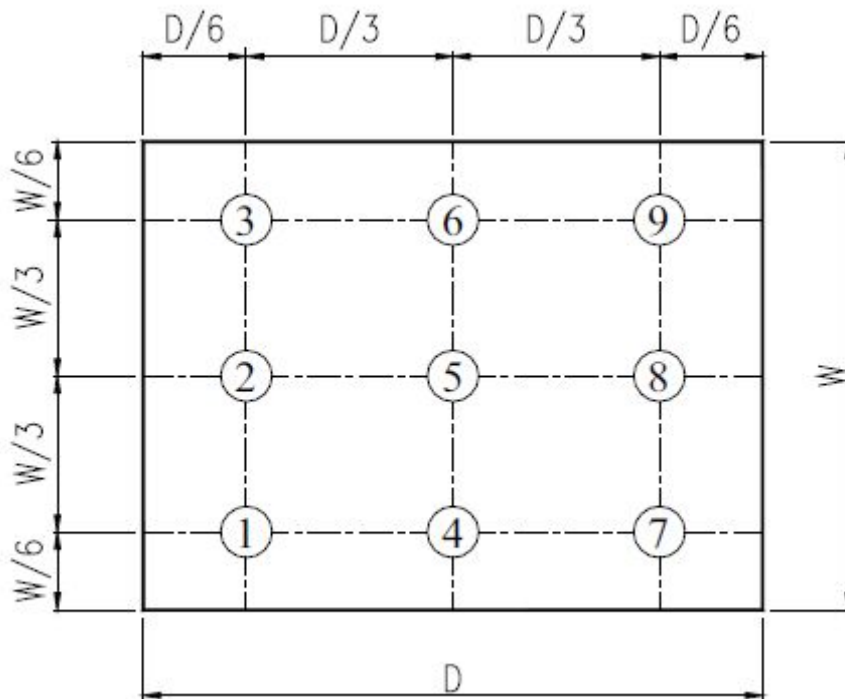

Fig. 2 Definition of uniformity

## 10. Environmental / Reliability Tests

No	Test Item	Condition	Judgment criteria
1	High Temp Operation	Ts=+50°C, 240hrs	Per table in below
2	Low Temp Operation	Ta=0°C, 240hrs	Per table in below
3	High Temp Storage	Ta=+60°C, 240hrs	Per table in below
4	Low Temp Storage	Ta= 20°C, 240hrs	Per table in below
5	High Temp & High Humidity Storage	Ta=+40°C, 90% RH 240 hours	Per table in below (polarizer discoloration is excluded)
6	Thermal Shock (Non operation)	20°C 30 min~+60°C 30 min, Change time:5min, 100 Cycles	Per table in below
7	ESD (Operation)	C=150pF, R=330Ω , 5points/panel Air:±8KV, 5times; Contact:±4KV, 5 times;	Per table in below
8	Vibration (Non operation)	Frequency range:10~55Hz, Stroke:1.5mm Sweep:10Hz~55Hz~10Hz 2 hours for each direction of X.Y.Z.	Per table in below
9	Shock (Non operation)	60G 6ms, ±X,±Y,±Z 3times, for each direction	Per table in below
10	Package Drop Test	Height:80 cm, 1 corner, 3 edges, 6 surfaces	Per table in below

INSPECTION	CRITERION(after test)
Appearance	No Crack on the FPC, on the LCD Panel
Alignment of LCD Panel	No Bubbles in the LCD Panel No other Defects of Alignment in Active area
Electrical current	Within device specifications
Function / Display	No Broken Circuit, No Short Circuit or No Black line No Other Defects of Display



## 11. Precautions for Use of LCD Modules

### 11.1 Safety

The liquid crystal in the LCD is poisonous. Do not put it in your mouth. If the liquid crystal touches your skin or clothes, wash it off immediately using soap and water.

### 11.2 Handling

- A. The LCD and touch panel is made of plate glass. Do not subject the panel to mechanical shock or to excessive force on its surface.
- B. Do not handle the product by holding the flexible pattern portion in order to assure the reliability
- C. Transparency is an important factor for the touch panel. Please wear clear finger sacks, gloves and mask to protect the touch panel from finger print or stain and also hold the portion outside the view area when handling the touch panel.
- D. Provide a space so that the panel does not come into contact with other components.
- E. To protect the product from external force, put a covering lens (acrylic board or similar board) and keep an appropriate gap between them.
- F. Transparent electrodes may be disconnected if the panel is used under environmental conditions where dew condensation occurs.
- G. Property of semiconductor devices may be affected when they are exposed to light, possibly resulting in IC malfunctions.
- H. To prevent such IC malfunctions, your design and mounting layout shall be done in the way that the IC is not exposed to light in actual use.

### 11.3 Static Electricity

- A. Ground soldering iron tips, tools and testers when they are in operation.
- B. Ground your body when handling the products.
- C. Power on the LCD module before applying the voltage to the input terminals.
- D. Do not apply voltage which exceeds the absolute maximum rating.
- E. Store the products in an anti-electrostatic bag or container.

### 11.4 Storage

- A. Store the products in a dark place at  $+25^{\circ}\text{C} \sim 10^{\circ}\text{C}$  with low humidity (40% RH to 60% RH). Don't expose to sunlight or fluorescent light.
- B. Storage in a clean environment, free from dust, active gas, and solvent.

### 11.5 Cleaning

- A. Do not wipe the touch panel with dry cloth, as it may cause scratch.
- B. Wipe off the stain on the product by using soft cloth moistened with ethanol. Do not allow ethanol to get in between the upper film and the bottom glass. It may cause peeling issue or defective operation. Do not use any organic solvent or detergent other than ethanol.

### 11.6 Cautions for installing and assembling

Bezel edge must be positioned in the area between the Active area and View area. The bezel may press the touch screen and cause activation if the edge touches the active area. A gap of approximately 0.5mm is needed between the bezel and the top electrode. It may cause unexpected activation if the gap is too narrow. There is a tolerance of 0.2 to 0.3mm for the outside dimensions of the touch panel and tail. A gap must be made to absorb the tolerance in the case and connector.

