



SmarterGlass

state-of-the-art display solutions

www.smarterglass.com
978 465 6190
sales@smarterglass.com

DLC Display Co., Limited

德爾西顯示器有限公司



MODEL No: DLC1020AIG

TEL: 86-755-86029824

FAX: 86-755-86029827

E-MAIL: sales@dlcdisplay.com

WEB: www.dlcdisplay.com



Record of Revision

Date	Revision No.	Summary
2009-05-06	1.0	Rev 1.0 was issued
2014-07-09	1.1	Update the pixel pitch

1. Scope

This data sheet is to introduce the specification of DLC1020AIG active matrix TFT module. It is composed of a color TFT-LCD panel, driver ICs, FPC and a backlight unit. The 10.2" display area contains 800(RGB) x480 pixels.

2. Application

Digital equipments which need color display, POS, mobile navigator/video systems.

3. General Information

Item	Contents	Unit
Size	10.2	inch
Resolution	800(RGB) x480	/
Interface	Digital	/
Technology type	a-Si	/
Pixel pitch	0.2775X0.276	mm
Pixel Configuration	R.G.B. Vertical Stripe	
Outline Dimension (W x H x D)	235.00x145.80 x6.1	mm
Active Area(W x H)	222.00x132.48	mm
Display Mode	Normally white, Transmissive	/
Backlight Type	LED	/

4. Outline Drawing

Technical drawing showing the outline of the DLC1020AIG module. The drawing includes a front view with dimensions (235.0, 116.6, 145.8, 90.0, 108.0, 54.0, 2.4, 4.2, 5.6, 4.76, 3.15, 71.0, 132.48, 135.7, 18.0, 40.0, 28.1), a side view with dimensions (108.0, 54.0, 2.4, 5.9, 108.0, 54.0, 2.4), and a detail view of the connector with dimensions (4.0, 0.5, 0.35, 14.5, 15.5).

Pin No.	Symbol	Pin No.	Symbol
1	POL	31	GND
2	STVD	32	G5
3	OEY	33	G4
4	CRV	34	G3
5	STVU	35	G2
6	GND	36	G1
7	EDG5L	37	G0
8	VCC	38	STHL
9	V9	39	REV
10	VGL	40	GND
11	V2	41	DCLK
12	VGH	42	VCC
13	V6	43	STHR
14	U/D	44	LD
15	VCOM	45	B5
16	GND	46	B4
17	AVDD	47	B3
18	V14	48	B2
19	V11	49	B1
20	V8	50	B0
21	V5	51	R/L
22	V3	52	V1
23	GND	53	V4
24	R5	54	V7
25	R4	55	V10
26	R3	56	V12
27	R2	57	V13
28	R1	58	AVDD
29	R0	59	GND
30	GND	60	VCOM

DLC Display Co., Limited
www.dlcdisplay.com

TITLE: DLC1020AIG
SCALE: UNIT: mm

DRAWN BY: BY: TITLE: DLC1020AIG
CHECKED BY: BY: DWG NO:
APPROVED BY: BY: DWG NAME:
CONFIRMED BY: BY: SHEET NO. OF

NOTES:
1.DISPLAY TYPE: a-Si TFT
2.DISPLAY MODULE: Transmissive ,Normally White
3.OPERATIN TEMP: -30° C---+85° C
4.STORAGE TEMP: -30° C---+85° C
5.Backlight: LED
6. RoHS Complicant

5. Interface signals

Pin No.	Symbol	I/O	Function	Remark
1	POL	I	Polarity selection	
2	STVD	I/O	Vertical start pulse input when U/D= H	Note 1
3	OEV	I	Output enable	
4	CKV	I	Vertical clock	
5	STVU	I/O	Vertical start pulse input when U/D= L	Note 1
6	GND	P	Power ground	
7	EDGSL	I	Select rising edge or rising/falling edge	
8	VCC	P	Power supply for digital circuit	
9	V9	I	Gamma voltage level 9	
10	VGL	P	Gate OFF voltage	
11	V2	I	Gamma voltage level 2	
12	VGH	P	Gate ON voltage	
13	V6	I	Gamma voltage level 6	
14	U/D	I	Up/down selection	Note 1,2
15	VCOM	I	Common voltage	
16	GND	P	Power ground	
17	AVDD	P	Power supply for analog circuit	
18	V14	I	Gamma voltage level 14	
19	V11	I	Gamma voltage level 11	
20	V8	I	Gamma voltage level 8	
21	V5	I	Gamma voltage level 5	
22	V3	I	Gamma voltage level 3	
23	GND	P	Power ground	
24	R5	I	Red data(MSB)	
25	R4	I	Red data	
26	R3	I	Red data	
27	R2	I	Red data	
28	R1	I	Red data	
29	R0	I	Red data(LSB)	
30	GND	P	Power ground	
31	GND	P	Power ground	
32	G5	I	Green data(MSB)	
33	G4	I	Green data	
34	G3	I	Green data	
35	G2	I	Green data	
36	G1	I	Green data	
37	G0	I	Green data(LSB)	
38	STHL	I/O	Horizontal start pulse input when R/L = L	Note 1
39	REV	P	Control signal are inverted or not	Note 3
40	GND	I	Power ground	
41	DCLK	I	Sample clock	
42	VCC	P	Power supply for digital circuit	
43	STHR	I/O	Horizontal start pulse input when R/L = H	Note 1
44	LD	I	Latches the polarity of outputs and switches the new data to outputs	

45	B5	I	Blue data (MSB)	
46	B4	I	Blue data	
47	B3	I	Blue data	
48	B2	I	Blue data	
49	B1	I	Blue data	
50	B0	I	Blue data (LSB)	
51	R/L	I	Right/ left selection	Note 1,2
52	V1	I	Gamma voltage level 1	
53	V4	I	Gamma voltage level 4	
54	V7	I	Gamma voltage level 7	
55	V10	I	Gamma voltage level 10	
56	V12	I	Gamma voltage level 12	
57	V13	I	Gamma voltage level 13	
58	AVDD	P	Voltage for analog circuit	
59	GND	P	Power ground	
60	VCOM	I	Common voltage	

Recommend connector: AF 730L-A2G1T(P-TWO.)

Note 1: Selection of scanning mode

Setting of scan control input		IN/OUT state for start pulse				Scanning direction
U/D	R/L	STVD	STVU	STHR	STHL	
GND	VCC	O	I	I	O	Up to down, left to right
VCC	GND	I	O	O	I	Down to up, right to left
GND	GND	O	I	O	I	Up to down, right to left
VCC	VCC	I	O	I	O	Down to up, left to right

Note 2: Definition of scanning direction.

Refer to the figure as below:

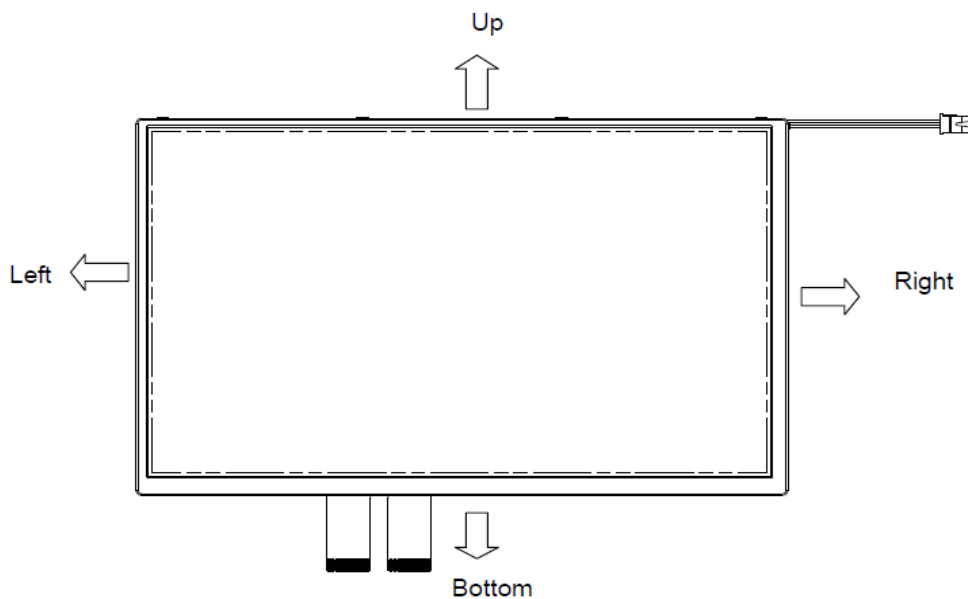

Note 3: When REV= "L" , normally REV= "H" , these data will be inverted.

6. Absolute maximum Ratings

6.1. Electrical Absolute max. ratings

Parameter	Symbol	MIN	MAX	Unit	Remark
Supply Voltage	VCC	-0.3	5	V	
	AVDD	-0.5	12	V	
	VGH	13	19	V	
	VGL	-12	-2	V	
	VGH-VGL	-	31	V	
Input Voltage	V1~V7	0.4 AVDD	AVDD-0.1	V	Note
	V8~V14	-0.3	0.6AVDD		

Note: $AVDD - 0.1 \cong V1 \cong V2 \cong V3 \cong V4 \cong V5 \cong V6 \cong V7 \cong V8 \cong V9 \cong V10 > V11 \cong V12 \cong V13 \cong V14 \cong AVSS + 0.1$.

6.2. Environment Conditions

Item	Symbol	MIN	MAX	Unit	Remark
Operating Temperature	TOP	-30	85	°C	
Storage Temperature	TST	-30	85	°C	

6.3. LED Backlight Absolute max. ratings

Item	Symbol	MIN	MAX	Unit	Remark
LED Forward Current	I _{LED}	--	25	mA	For each LED

7. Electrical Specifications

7.1 Electrical characteristics

GND=0V, Ta=25°C

Item	Symbol	MIN	TYP	MAX	Unit	Remark
Supply Voltage	VCC	3.0	3.3	3.6	V	
	AVDD	9.0	9.2	9.4	V	
	VGH	15.3	16.0	16.7	V	
	VGL	-7.7	-7.0	-6.3	V	
	VGH-VGL	3	3.3	3.6	V	
Input signal voltage	VCOM	3.65	3.85	4.05	V	$(V1+V14)/2 = 4.9V$
	V1~V7	0.4 AVDD	-	AVDD -0.1	V	
	V8~V14	0.1	-	0.6 AVDD	V	
Input logic Voltage	VIL	0.7VCC	-	VCC	V	
	VIH	0	-	0.3VCC	V	

7.2 LED Backlight

Ta=25°C

Item	Symbol	MIN	TYP	MAX	Unit	Remark
Forward Current	IF	-	200	220	mA	
Forward Voltage	VF	-	9.3	10.5	V	

8. Command/AC Timing

8.1 Timing Diagram

Item	Symbol	Values			Unit	Remark
		Min.	Typ.	Max.		
DCLK frequency	Fdclk	-	40	45	MHz	
DCLK cycle	Tcph	22	25	-	ns	
DCLK pulse width	Tcw	8	-	-	ns	
Data set-up time	Tsu	4	-	-	ns	
Data hold time	Thd	2	-	-	ns	
Time that the last data to LD	Tld	1	-	-	Tcph	
Pulse width of LD	Twld	2	-	-	Tcph	
Time that LD to STHL/R	Tlds	5	-	-	Tcph	
POL set-up time	Tpsu	6	-	-	ns	
POL hold time	Tphd	6	-	-	ns	
CKV frequency	Fvclk	-	-	200	KHz	
CKV rise time	Trck	-	-	100	ns	
CKV falling time	Tfck	-	-	100	ns	
CKV pulse width	PWCLK	500	-	-	ns	
Horizontal display timing range	Tdh	-	800	-	Tcph	
Horizontal timing range	Th	-	1056	-	Tcph	
STVU/D setup time	Tsuv	200	-	-	ns	
STVU/D hold time	Thdv	300	-	-	ns	
STVU/D delay time	Tdt	-	-	500	ns	
Driver output delay time	Tdo	-	-	900	ns	
Output rise time	Ttlh	-	500	1000	ns	
Output falling time	Tthl	-	400	800	ns	
OEV pulse width	Twcl	1	-	-	us	
OEV to Driver output delay time	Toe	-	-	900	ns	
Horizontal lines per field	Tv	512	525	610	Line	
Vertical display timing range	Tvd	-	480	-	Line	

8.2 Timing Diagram

EDGSL="0", Default

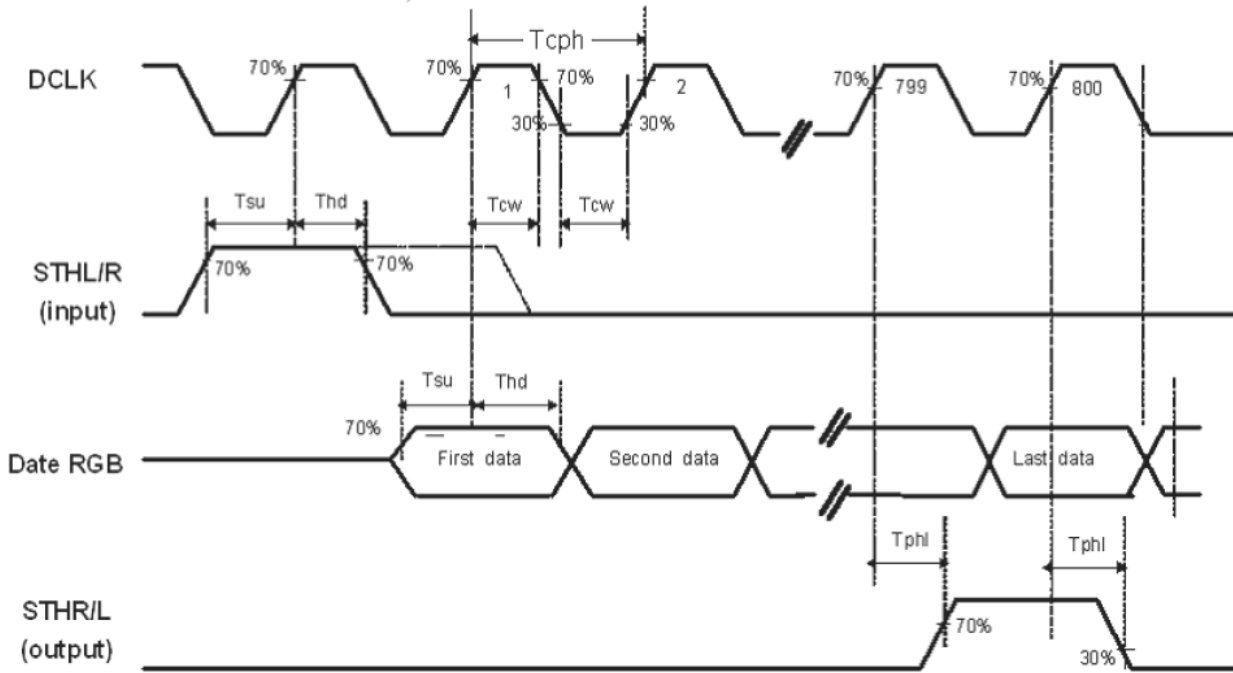

EDGSL="1"

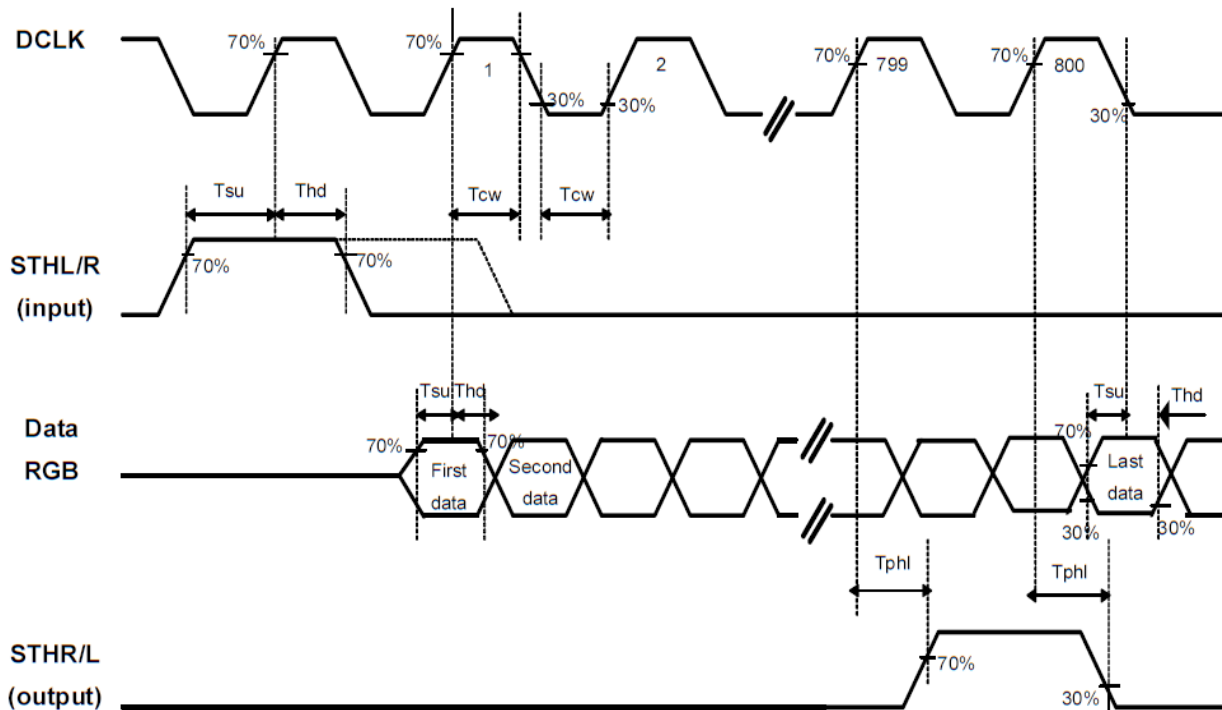

Horizontal timing 1

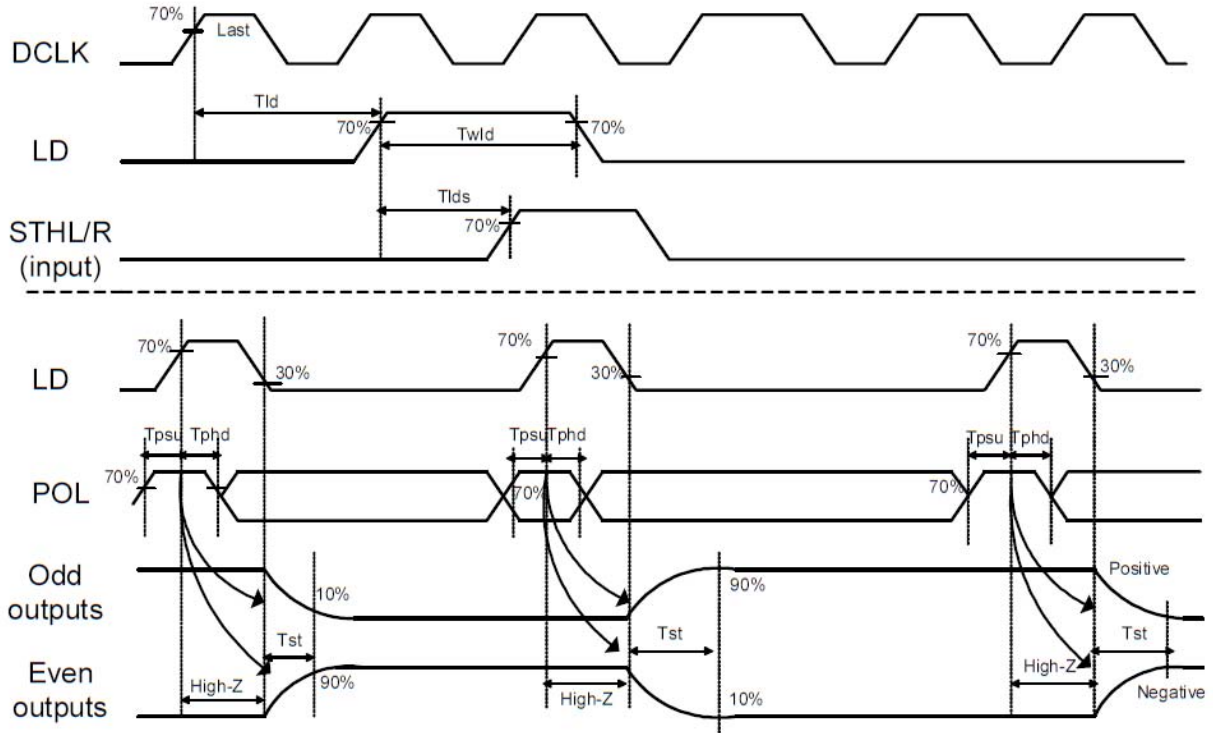

Horizontal timing 2

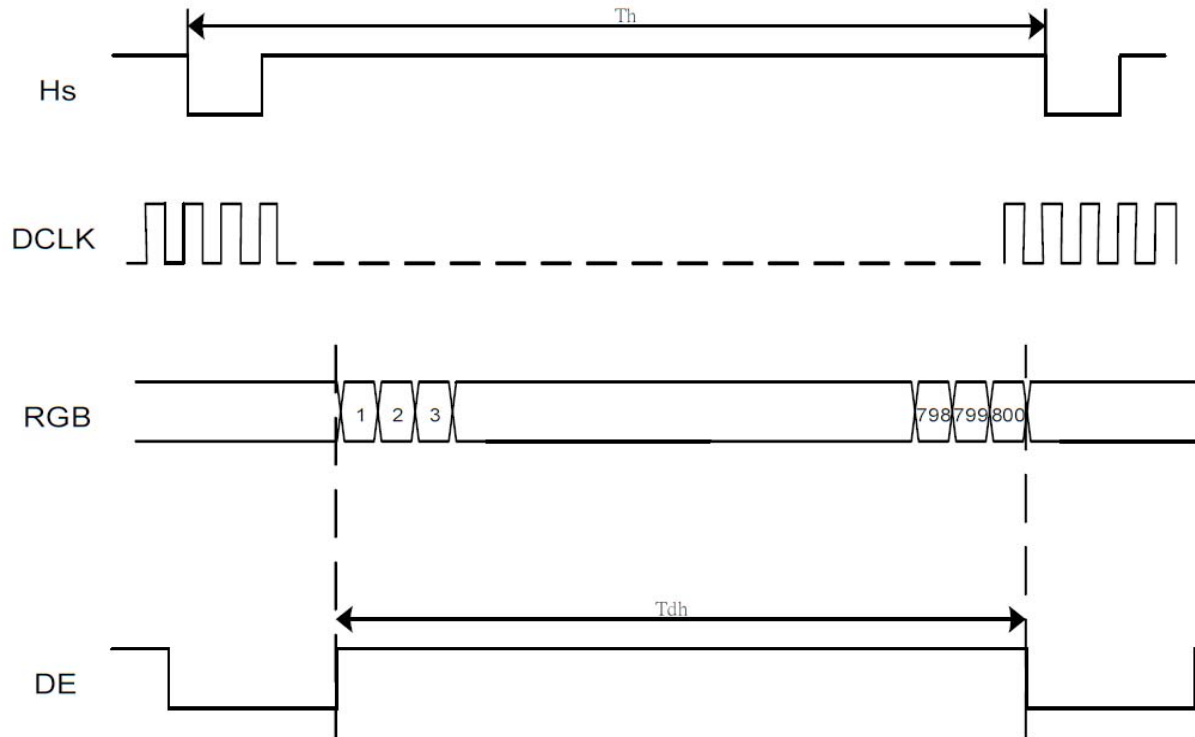

Vertical shift clock timing

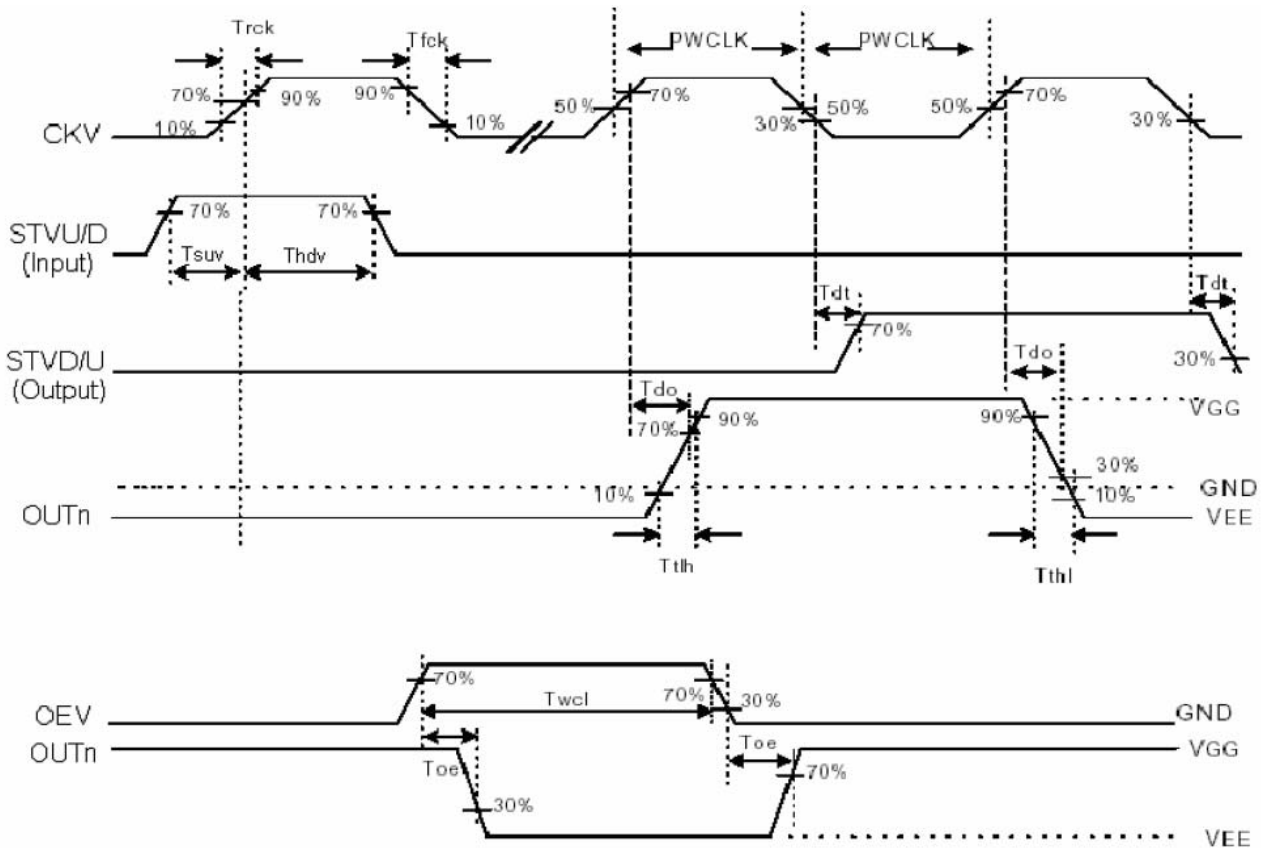

Vertical timing (from up to down)

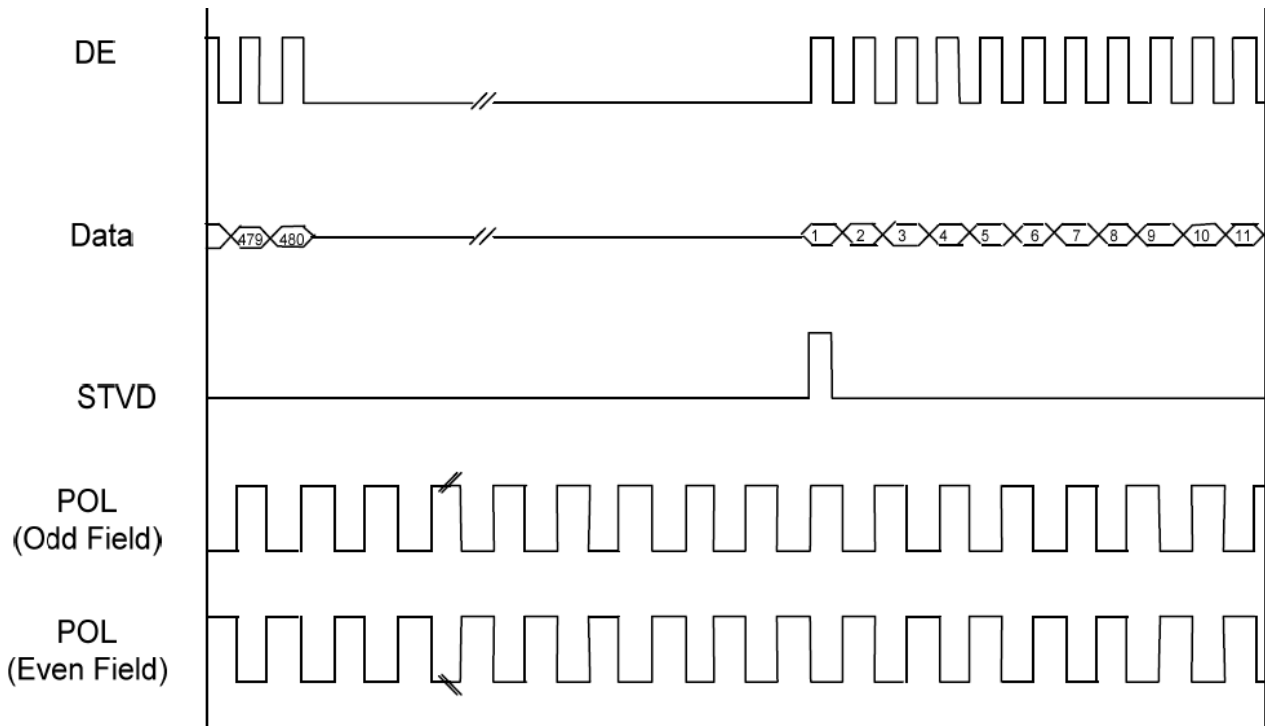

Vertical timing

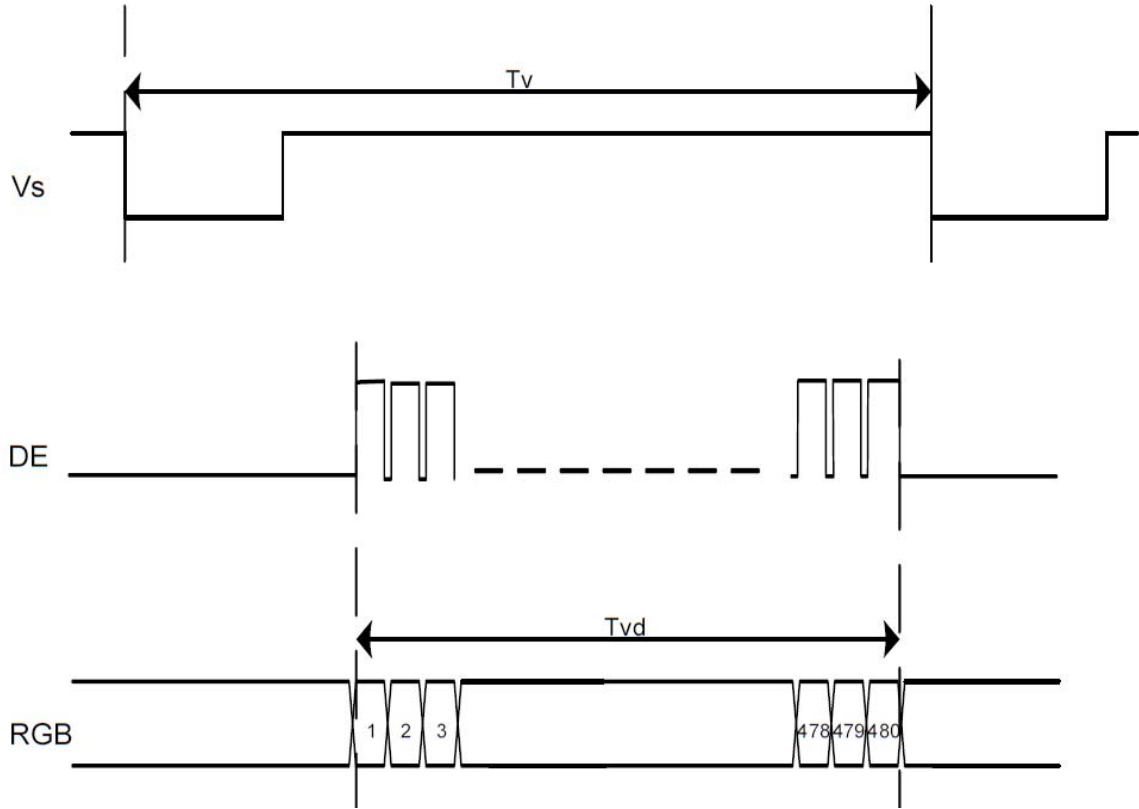

9. Optical Specification

Ta=25°C

Item	Symbol	Condition	Min	Typ.	Max.	Unit	Remark
Contrast Ratio	CR	$\theta=0^\circ$	250	300	-		Note1 Note2
Response Time	Tr	25°C	-	15	30	ms	Note1
	Tf		-	20	40		Note3
View Angles	ΘT	$CR \geq 10$	35	45	-	Degree	Note 4
	ΘB		55	65	-		
	ΘL		55	65	-		
	ΘR		55	65	-		
Chromaticity	White	x	Brightness is on	0.26	0.31	0.36	Note5, Note1
		y		0.28	0.33	0.38	
Luminance	L		200	250	-	cd/m ²	Note1 Note6
Uniformity	U		70	75	-	%	Note1 Note7

Note 1: Definition of optical measurement system.

Temperature = 25°C(±3°C)

LED back-light: ON, Environment brightness < 150 lx

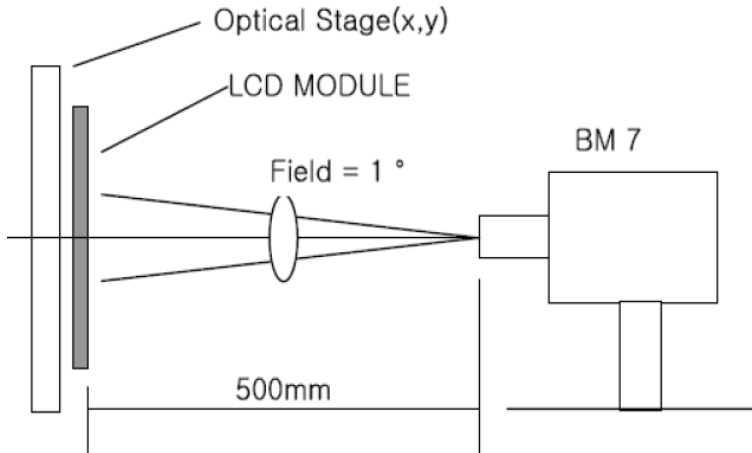

Note 2: Contrast ratio is defined as follow:

$$\text{Contrast Ratio} = \frac{\text{Surface Luminance with all white pixels}}{\text{Surface Luminance with all black pixels}}$$

Note 3: Response time is defined as follow:

Response time is the time required for the display to transition from black to white (Rise Time, Tr) and from white to black (Decay Time, Tf).

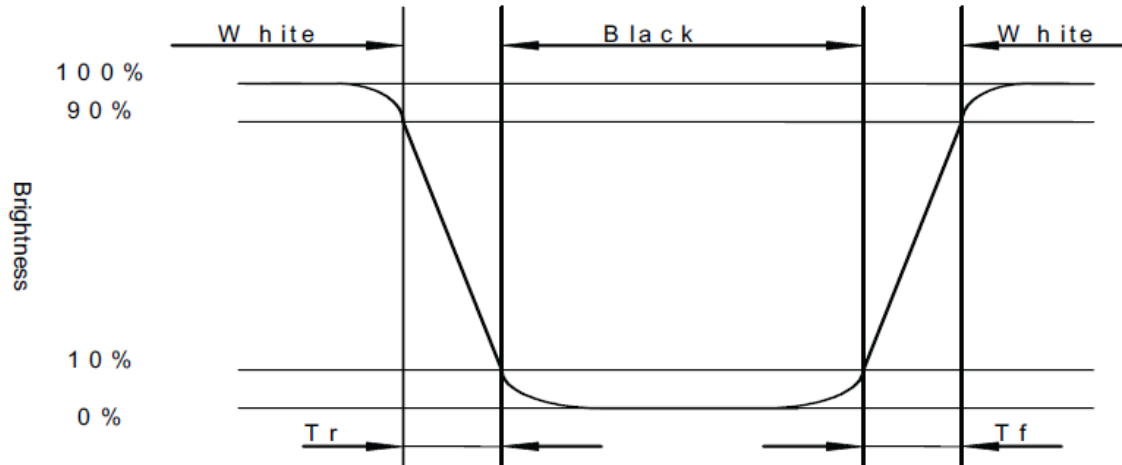

Note 4: Viewing angle range is defined as follow:

Viewing angle is measured at the center point of the LCD.

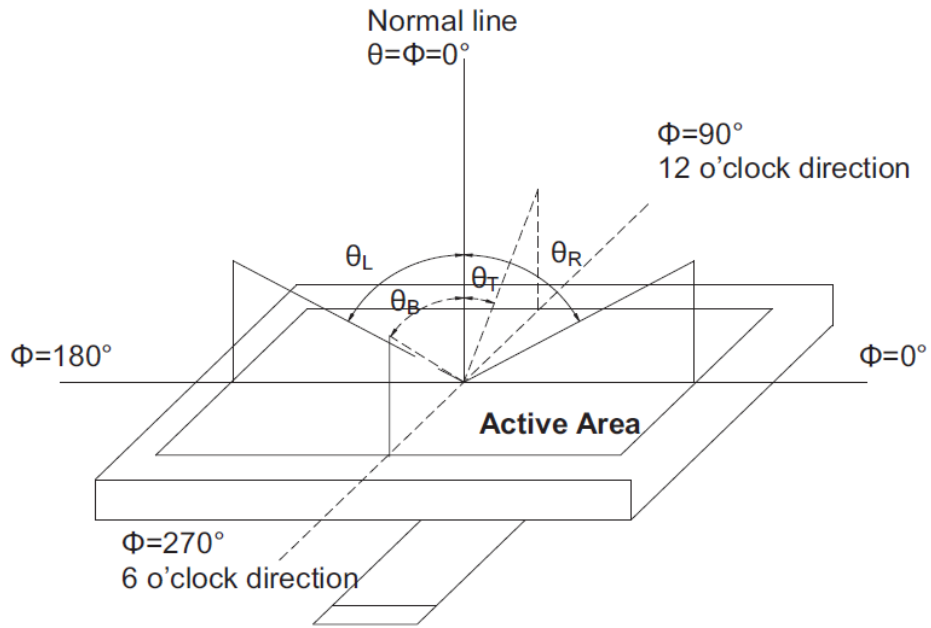

Note 5: Color chromaticity is defined as follow: (CIE1931)

Color coordinates measured at center point of LCD.

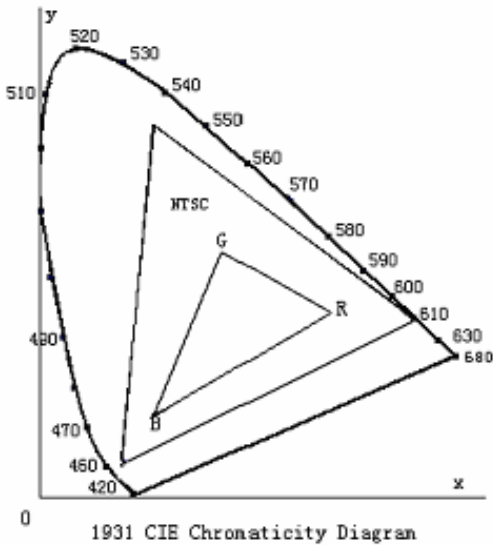

$$S = \frac{\text{area of RGB triangle}}{\text{area of NTSC triangle}} \times 100\%$$

Note 6: Luminance is defined as follow:

Luminance is defined as the brightness of all pixels “White” at the center of display area on optimum contrast.

Note 7: Luminance Uniformity is defined as follow:

Active area is divided into 9 measuring areas (Refer Fig. 2). Every measuring point is placed at the center of each measuring area.

$$\text{Uniformity (U)} = \frac{\text{Minimum Luminance(brightness) in 9 points}}{\text{Maximum Luminance(brightness) in 9 points}}$$

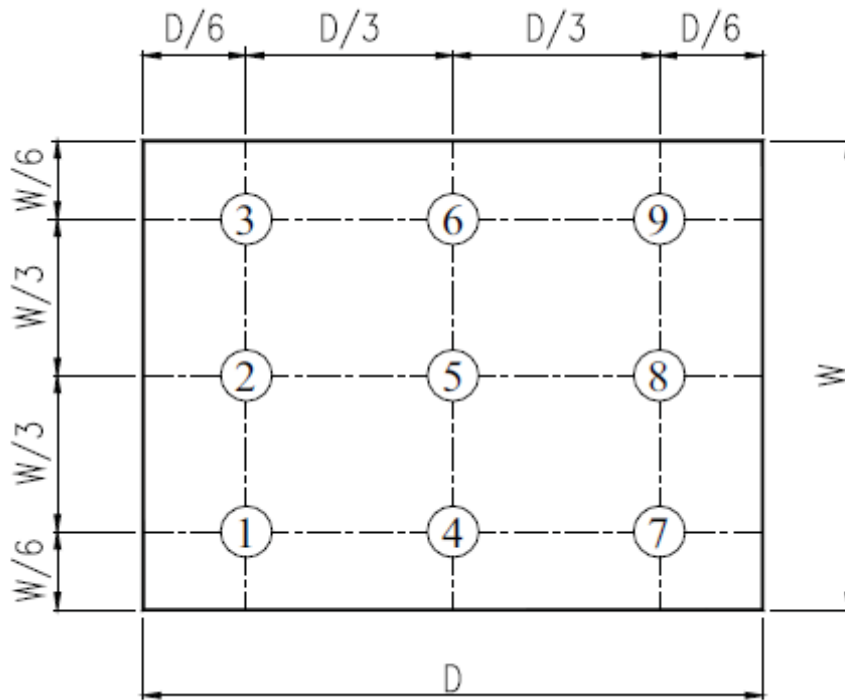

Fig. 2 Definition of uniformity

10. Environmental / Reliability Tests

No	Test Item	Condition	Judgment criteria
1	High Operation Temp	Ts= +85°C, 240hrs	Per table in below
2	Low Operation Temp	Ta=-30°C, 240hrs	Per table in below
3	High Temp Storage	Ta= +85°C, 240hrs	Per table in below
4	Low Temp Storage	Ta=-30°C, 240hrs	Per table in below
5	High Temp & High Humidity Storage	Ta= +60°C, 90% RH 240 hours	Per table in below (polarizer discoloration is excluded)
6	Thermal Shock (Non-operation)	-30°C 30 min~+85°C 30 min, Change time:5min,100 Cycles	Per table in below
7	ESD (Operation)	C=150pF, R=330Ω , 5points/panel Air:±8KV, 5times; Contact:±4KV, 5 times;	Per table in below
8	Vibration (Non-operation)	Frequency range:10~55Hz, Stroke:1.5mm Sweep:10Hz~55Hz~10Hz 2 hours for each direction of X.Y.Z.	Per table in below
9	Shock (Non-operation)	100G 6ms, ±X,±Y,±Z 3times, for each direction	Per table in below
10	Package Drop Test	Height:60 cm, 1 corner, 3 edges, 6 surfaces	Per table in below

INSPECTION	CRITERION(after test)
Appearance	No Crack on the FPC, on the LCD Panel
Alignment of LCD Panel	No Bubbles in the LCD Panel No other Defects of Alignment in Active area
Electrical current	Within device specifications
Function / Display	No Broken Circuit, No Short Circuit or No Black line No Other Defects of Display

11. Precautions for Use of LCD Modules

11.1 Safety

The liquid crystal in the LCD is poisonous. Do not put it in your mouth. If the liquid crystal touches your skin or clothes, wash it off immediately using soap and water.

11.2 Handling

- A. The LCD and touch panel is made of plate glass. Do not subject the panel to mechanical shock or to excessive force on its surface.
- B. Do not handle the product by holding the flexible pattern portion in order to assure the reliability
- C. Transparency is an important factor for the touch panel. Please wear clear finger sacks, gloves and mask to protect the touch panel from finger print or stain and also hold the portion outside the view area when handling the touch panel.
- D. Provide a space so that the panel does not come into contact with other components.
- E. To protect the product from external force, put a covering lens (acrylic board or similar board) and keep an appropriate gap between them.
- F. Transparent electrodes may be disconnected if the panel is used under environmental conditions where dew condensation occurs.
- G. Property of semiconductor devices may be affected when they are exposed to light, possibly resulting in IC malfunctions.
- H. To prevent such IC malfunctions, your design and mounting layout shall be done in the way that the IC is not exposed to light in actual use.

11.3 Static Electricity

- A. Ground soldering iron tips, tools and testers when they are in operation.
- B. Ground your body when handling the products.
- C. Power on the LCD module before applying the voltage to the input terminals.
- D. Do not apply voltage which exceeds the absolute maximum rating.
- E. Store the products in an anti-electrostatic bag or container.

11.4 Storage

- A. Store the products in a dark place at $+25^{\circ}\text{C} \pm 10^{\circ}\text{C}$ with low humidity (40% RH to 60% RH). Don't expose to sunlight or fluorescent light.
- B. Storage in a clean environment, free from dust, active gas, and solvent.

11.5 Cleaning

- A. Do not wipe the touch panel with dry cloth, as it may cause scratch.
- B. Wipe off the stain on the product by using soft cloth moistened with ethanol. Do not allow ethanol to get in between the upper film and the bottom glass. It may cause peeling issue or defective operation. Do not use any organic solvent or detergent other than ethanol.

11.6 Cautions for installing and assembling

Bezel edge must be positioned in the area between the Active area and View area. The bezel may press the touch screen and cause activation if the edge touches the active area.

A gap of approximately 0.5mm is needed between the bezel and the top electrode. It may cause unexpected activation if the gap is too narrow. There is a tolerance of 0.2 to 0.3mm for the outside dimensions of the touch panel and tail. A gap must be made to absorb the tolerance in the case and connector.

