

Tracking Regulations

Amended to January 1, 2010

Published by The American Kennel Club

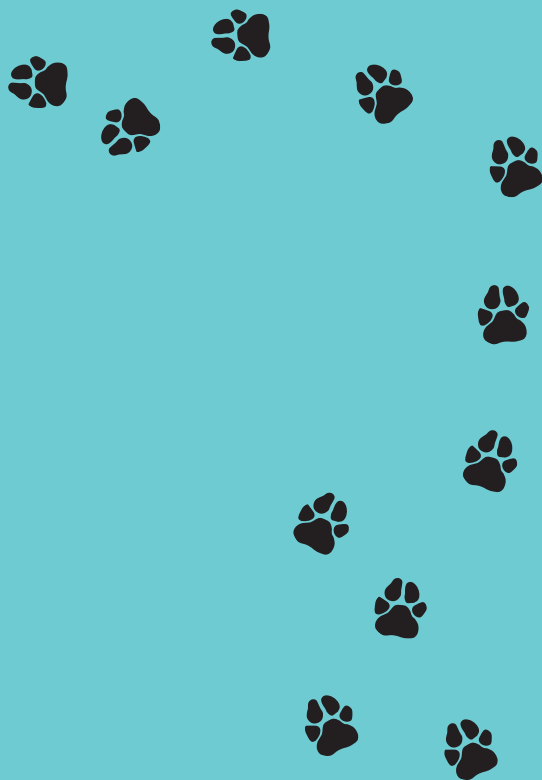

**AMERICAN
KENNEL CLUB®**

AMERICAN KENNEL CLUB'S MISSION STATEMENT

The American Kennel Club is dedicated to upholding the integrity of its Registry, promoting the sport of purebred dogs and breeding for type and function. Founded in 1884, the AKC and its affiliated organizations advocate for the purebred dog as a family companion, advance canine health and well-being, work to protect the rights of all dog owners and promote responsible dog ownership.

Table of Contents

Chapter 1	
General Regulations	Page 1
Chapter 2	
Regulations for Performance and Judging	Page 7
Chapter 3	
Tracking Dog Test (TD).....	Page 13
Chapter 4	
Tracking Dog Excellent Test (TDX)	Page 15
Chapter 5	
Variable Surface Tracking Test (VST)	Page 18
Chapter 6	
Champion Tracker Title Certificate.....	Page 21
Guidelines for Tracking Tests	Page 22
Glossary	Page 38
Index	Page 39

TRACKING REGULATIONS

Purpose of Tracking Tests

The purpose of a tracking test is to demonstrate the dog's ability to recognize and follow human scent, a skill useful in the service of mankind.

Tracking, by nature, is a vigorous, noncompetitive outdoor sport. Tracking tests demonstrate the willingness and enjoyment of the dog in its work and should always represent the best in sportsmanship and camaraderie by the people involved.

CHAPTER 1

General Regulations

Section 1. Tracking, Tracking Dog Excellent, and Variable Surface Tracking Tests. A club that meets AKC® requirements may apply to hold a tracking test. A club may designate a test as a combined tracking test if more than one test, TD, TDX, or VST is offered. A combined tracking test may occur over one (1) or more consecutive days. The club must identify the test as a combined tracking test on the application to the AKC and in the Premium List. Tracking tests may not be held at the same site within three (3) days from test day to test day with the following exception: A club may hold a test, or a combined tracking test lasting one (1) or more consecutive days at the same site, as long as the maximum track limit allowed for any judge in one day is not exceeded, the tracks meet spacing requirements for each of the respective test levels and those portions of the site used for tracks plotted for the first day are not reused on the second or subsequent days.

A club will not be approved to hold a tracking test on the same day as its show or obedience trial. A National Specialty Breed Club, however, may be approved to hold a tracking test on the same day or days as other events at their National Specialty shows.

If a tracking test is to be held within seven (7) days after a club's show or obedience trial, it may be announced in the premium list for the show or trial. The tracking test entries may be included in the show or obedience trial catalog; otherwise, a separate premium list must be prepared for licensed or member club tracking tests. In either case, the premium list will include directions to the test site and the draw time for the running order of tracks.

Whenever a tracking test is announced in the premium list of a licensed or member show or obedience trial, the club may name someone to receive the tracking test entries other than the person designated to receive the show or obedience trial entries. If a tracking test is announced in a show or trial premium list, the show or trial closing date will apply to tracking entries; otherwise, the closing date for tracking test entries will be at least ten (10) days prior to the tracking test.

At the tracking test, a club must provide catalogs or a printed listing of each entered dog and each alternate. The catalog or listing must contain all the identifying information that normally appears in a dog show catalog. The identifying information must include the name of the certifying judge and the date of certification for every dog requiring certification prior to entry in a licensed or member tracking test.

The club will retain the entries, and certifications, for six (6) months following the test.

The presence of a veterinarian will not be required at a tracking test.

A club may be approved to hold an unlimited number of tracking tests, provided it has the land and personnel available.

The test secretary's phone number or email address must be published in the premium list.

Section 2. Tracking Test Chairperson and Event Committee. A club holding a licensed or member tracking test must appoint a tracking test

chairperson, a tracking test secretary (who may also act as chairperson) and an Event Committee. The Event Committee will be composed of at least five (5) members of the club and may include the chairperson and the tracking test secretary. A person designated as the chief tracklayer is responsible for coordinating the track laying schedule with the judges on the test day.

This committee will exercise all authority vested in an event committee and will have sole jurisdiction over all matters that may properly come before it. The committee will also be responsible for compliance with Chapter 2, Sections 28 (Abuse of Dogs) and 29 (Declining Entries), of the *Obedience Regulations*.

At least five (5) members of the Event Committee will be present throughout the test. Test secretaries and chairpersons will not be eligible to judge or enter any tracking event at which they act in these official capacities.

Section 3. Sanctioned Tracking Matches. The AKC approves clubs to hold sanctioned tracking matches. All these regulations govern sanctioned tracking matches, except those that specify they apply only to licensed or member tracking tests or are stated otherwise in the *Match Regulations*. Passing a sanctioned tracking match will not earn a dog a tracking title.

If one of the judges at a sanctioned tracking match is an approved or provisional tracking judge, a dog that passes may be certified to enter a licensed or member Tracking Dog (TD) tracking test.

Section 4. American Kennel Club® Sanction. AKC sanction must be obtained by any club that holds AKC tracking events or for any type of event for which a club solicits or accepts entries from non-members.

Section 5. Rules Applying to Dog Shows and Obedience Regulations. Except as these *Tracking Regulations* may otherwise provide, the *Obedience Regulations*, *Obedience Judges Guidelines*, and *Rules Applying to Dog Shows*, where applicable, will govern the conduct of tracking tests and will apply to all persons and dogs participating in them.

The sections of the *Obedience Regulations and Obedience Judges Guidelines* that apply directly to tracking tests are:

Chapter 1 - General Regulations

Section 3 (Entries)

Section 5 (Tracking Tests)

Section 11 (Immediate Family)

Section 12 (Purebred Dogs Only)

Section 13 (Unregistered Dogs)

Section 17 (Disqualification, Ineligibility, Excusal, and Change in Appearance of Dogs)

Chapter 2 - Regulations for Performance and Judging

Section 5 (No Added Requirements)

Section 26 (Training and Warm-up on the Grounds)

Section 28 (Abuse of Dogs)

Section 29 (Declining Entries)

Chapter 9 - Versatile Companion Dog

Section 1 (Versatile Companion Dog Title)

Section 2 (Versatile Companion Champion Title)

Obedience Judges Guidelines

Chapter 1 – The Obedience Judge

All clubs holding tests under AKC rules and regulations must have available at each test, through their test committees, a copy of the latest edition of the *Rules Applying to Dog Shows*, the *Obedience Regulations*, the *Tracking Regulations*, and the *Dealing with Misconduct* booklet.

Section 6. Risk. Owners or agents entering dogs in tracking tests do so at their own risk and agree to abide by all AKC rules and regulations.

Section 7. Compliance with Regulations and Standards. In accordance with the certification on the entry form, the handler of each dog and the person signing each entry form must be familiar with the *Tracking Regulations* applicable to the test in which the dog is entered.

Section 8. Identification. No badges, club jackets, coats with kennel names thereon, or ribbon prizes may be worn or displayed, and no other visible means of identification may be used by an individual while under judgment with a dog in the tracking field.

Section 9. Eligibility. No dog may be entered more than once at any one tracking test. At a combined tracking test TD, TDX, or VST, a dog may be entered in more than one test under the following conditions provided preference in the draw is given to untitled dogs:

1. at a combined tracking test where each test is held on a separate day in Alaska, Hawaii, or any US territory outside the continental US
2. at a combined tracking test where each test is held on a separate day in conjunction with a National Specialty

Section 10. Dogs that May Not Compete. No dog less than six (6) months of age may participate in tracking events. No dog belonging wholly or in part to a judge, test secretary, superintendent, or any member of such a person's household, may be entered in any tracking test at which such person officiates or is scheduled to officiate. Nor may they handle or act as agent for any dog entered at that tracking test. The official veterinarians will not exhibit or act as agent or handle at the test, and dogs owned wholly or in part by them will not be eligible to be entered at the test.

No dog owned wholly or in part by a superintendent, any employee of that superintendent, or any person residing in the same household as any of the foregoing will be eligible to be entered at any test held 30 days before or after a test that the superintendent has been approved to service by the AKC. Nor may that person exhibit or act as an agent or handler.

For the purpose of this section, the employees of a superintendent include only those individuals who represent the superintendent or superintending organization at dog shows.

No judges or any persons residing in the same household as the judges will exhibit or act as agent or handle at a tracking test at which they are judging. Dogs owned wholly or in part by such judges or any members of their household will not be eligible to be entered at such events.

Subject to the foregoing, members of a judge's immediate family who no longer live in the same household may enter or handle a dog at a test if the judge is not officiating over any competition that might involve the relative's dog.

Section 11. Duration of Test. In the event of an unforeseen emergency, the test secretary and event committee, upon the recommendation of the judges, may extend the duration of a tracking test by one day or more within a 15-day period after the original date, provided that the change of date is satisfactory to the majority of the handlers of entered dogs. If a handler chooses not to participate in the rescheduled test, the next eligible alternate will be given the option to run. The entry fee will be refunded to the owner of the original entered dog. If a satisfactory date cannot be agreed upon, the test will be canceled.

Section 12. Ribbons and Prizes. If ribbons or prizes are offered at licensed or member club tracking tests, they shall be awarded only to dogs that pass the test. Such ribbons or rosettes will be dark green, at least two (2) inches wide and approximately eight (8) inches long and will bear on the face a facsimile of the AKC seal and the words "Tracking Test." The name of the test-giving club, the date of the test, and the name of the city or town where the test site is located may be either on the face of the ribbon or on a tag on the back of the ribbon.

If ribbons are given to dogs that "pass" sanctioned tracking matches, they will be green with pink edges and have the words "Sanctioned Tracking Match" printed on them. These ribbons may be of any size or design.

Section 13. Drawing for Entries and Alternates List. Entries for a tracking test will be accepted until the official closing date and time, even if the advertised test limit has been reached. A random drawing of all entries, to determine which dogs will participate in the test, will be held within 48 hours after the closing date and time. The drawing will be open to all interested persons. The test secretary will draw entries on the date, hour, and location specified in the premium list and ensure the draw is conducted in a random and impartial manner. If the advertised limit is not reached, a drawing is optional. The results of the draw will be made available to the people present at the draw.

The draw for tracks in each test TD, TDX, VST, shall be conducted with untitled dogs (see glossary) until the available tracks in each test has been filled with untitled dogs. When the advertised limit of entries has been drawn, all remaining entries will be drawn for positions on the alternates list with untitled dogs being drawn first followed by titled dog entries. Untitled dogs will have priority for the draw in all tests.

Following the draw, the test secretary will attempt to contact all entrants and advise them of the outcome within 48 hours.

A dog drawn into the test is required to be at the test site only on the day it is scheduled to run as identified in the Judging Program Alternates will be given the option to accept or decline being placed on the alternates list. Those who accept will be placed on the alternates list in the order in which they were drawn. Those who opt to decline will have their entry fees and certification returned. Entrants and alternates who do not run in a test but are replaced by alternates who run in the test will have full entry fees and certifications returned. Any other conditions under which the entry fees are returned to entrants or alternates will be so stated in the premium list.

The complete list of alternates, whether they accepted or declined, will be included with the Test Report sent to the AKC following the test.

Section 13a Combined Tests Exchange Policy. If it is a combined test, it must be stated as such in the premium list. The exchange policy will be in effect with the

available tracks being filled first with untitled dogs followed by titled dogs. If the limit for entries is not reached in one test at a combined TD, TDX, VST test and the limit for entries is exceeded in the other test, the number of tracks may be exchanged, up to the day of plotting up to a maximum of twelve (12) TDs, (6) TDXs or eight (8) VSTs, not to exceed the limits set in Section 15 of this chapter, provided it is published in the premium list.

Section 13b Specialty Club Option. Specialty clubs have the option of opening their tracking tests to all breeds. Specialty clubs may choose either (1) only their own breed, or (2) through the use of a lottery draw, may allow other breeds to enter their specialty using the following procedure:

Draw (1) Specialty breed without a title;

Draw (2) Specialty breed with a title;

Draw (3) Other breeds without a title;

Draw (4) Other breeds with a title.

Section 13c Combined TDX/VST in Alaska, Hawaii and Outside Continental US or National Specialties. When the draw is associated with a combined TDX/VST test, where the exception for eligibility according to Chapter 1, Section 9 allows the same untitled dog to be entered in both the TDX and VST, the draw will be conducted to allow as many untitled dogs as possible at least one slot in a combined test. The exception requires that preference be given to untitled dogs that have not already been given a slot in the preceding test.

Section 13d Test Worker Option. A club may set aside tracks for test workers from previous tests, as defined and identified by the test giving club. This information and the number of tracks to be set aside must be published in the premium list. Entries from workers are to be drawn first, up to the limits shown in the table below. Once the tracks set aside for workers are filled, any remaining test worker entries will be added to the non-worker entries for the draw of the remaining tracks. There will be no separate alternate list for test workers only. A test worker may not benefit from a track set aside at a test in which they are working. Deviations from the table are not permitted for any test, combined test or multiple tests.

<u>Tracks</u>	<u>TD</u>	<u>TDX</u>	<u>VST</u>
<u>1-4</u>	<u>0</u>	<u>0</u>	<u>0</u>
<u>5</u>	<u>0</u>	<u>1</u>	<u>1</u>
<u>6</u>	<u>2</u>	<u>2</u>	<u>2</u>
<u>7-8</u>	<u>2</u>	<u>2</u>	<u>2</u>
<u>9-11</u>	<u>3</u>	<u>2</u>	<u>2</u>
<u>12 or more</u>	<u>4</u>	<u>4</u>	<u>2</u>

Section 13e Alternate List for Multiple-Day Test. The alternate list for tests that last for two (2) or more consecutive days, at the same site will apply to all days. Any test slot that becomes available prior to the first day of the test, for any day of the test, will be filled starting from the first entry on the alternate list. Any alternate that declines an offered slot, prior to test day, is considered to be withdrawn from the alternate list. If a slot does not become available until test day, it is filled

starting from the first entry on the alternate list that has not previously declined a slot and is present at the test site.

Section 14. Judging Program. The test-giving club will prepare a program containing all entry numbers in the order in which they were drawn or in the order received when the total entry falls short of the advertised limits. The program will also include the scheduled time and location of the drawing for the running order of tracks, as well as directions to the location of the drawing. In the event of a two (2) or more consecutive day test, the day on which each entry number is to run will be included in the judging program. The judging program will provide a cell phone number of a committee member present at the test site the day(s) of the test. The club will mail a copy of the program to the owner of each entered dog, to each judge, and to the AKC no less than seven (7) days prior to the test. Prior to the draw for test day running order, the judges will be provided with the catalog number, breed, sex, and AKC number for each dog entered. The program will be printed in the catalog.

Section 15. Judging Assignments. Each dog must be judged by two judges. The maximum number of dogs two judges may test at a TD test in one day is twelve (12). The maximum number of dogs two judges may judge at a TDX test in one day is six (6). The maximum number of dogs two judges may judge at a VST test in one day is eight (8).

When more than one test is offered on the same day, the following substitution factor will be in effect:

2 TDs = 1 TDX

2 TDs = 1 VST

1 TDX = 1 VST

At any combined test(s), which may include VST, the maximum number of dogs two judges may test in one day will be equal to twelve (12) TDs or six (6) TDXs.

Section 16. Club Responsibilities. The Event Committee and/or the officials of the club holding the tracking test are responsible for providing personnel, equipment, and fields suitable for tracks that meet the requirements of these *Regulations*. The judges must check the equipment and fields provided for use before beginning to plot the tracks and must report to the AKC after the test any undesirable conditions or deficiencies not corrected promptly by the club.

If requested by one or both judges, the club must provide ground maps, roughly to scale, of the tracking area showing the major features of terrain and boundaries about sixty (60) days prior to the tracking test.

Section 17. Dogs Running Free. Due to the changing nature of the fields being used by clubs for tracking tests and the increased population at these sites by the general public, dogs must be “on lead” at all times on any area of the tracking site. This will not apply to dogs owned or under the control of individuals not associated with the tracking test.

CHAPTER 2

Regulations for Performance and Judging

Section 1. Decisions. The judges are in sole charge of the tracking field (the area in which the tracks are laid) until the assignment is completed. The decisions of the judges will be final in all matters affecting evaluation and the working of the dogs and their handlers. Judges are not required to explain their decisions and need not enter into a discussion with any entrant who appears to be dissatisfied.

The tracking Event Committee will decide all other matters arising at the test, including protests against dogs made under Chapter 15 of the *Rules Applying to Dog Shows*, subject to AKC rules and regulations.

Section 2. Disturbances. The judges will remove from participation any dog that its handler cannot control, any handler who interferes willfully with another entrant or dog, and any handler who disciplines or abuses a dog while the dog is being judged.

Abuse of a dog must be reported to the event committee.

The judges may excuse any dog they feel is unfit to participate. If a dog or handler is excused by the judges, the reason will be noted in the judges' books. A judge who is aware of any assistance, interference, or attempt to control a dog while it is being judged must act promptly to stop such behavior. If in the judges' opinion the circumstances warrant, the dog will be failed.

Section 3. Complexity. At a tracking test, all tracks should be of approximately equal complexity within the limitations of changing cover and terrain. Judges should make every effort to age all tracks for about the same length of time. The same methods and standards will be used in plotting tracks and judging the working of all breeds of dogs.

Judges are not to inject their own variations into tracking tests but must see that each handler and dog is tested on a track that completely satisfies the tracking regulations. A handler who is familiar with these regulations should be able to enter a test without confronting an unexpected requirement.

Section 4. Plotting. All TD and TDX tracks will be started in cover of a type predominant in the area of the field that contains the first leg and turn of the track. Both judges must be present on the day of plotting, and both judges must walk every track. At a TD test, only regular status judges may divide the plotting responsibilities. Each judge must then walk the other judge's tracks. If extenuating circumstances prevent either judge from walking every track at a TD test, the circumstances must be fully explained in a report submitted with the judges' books. Plotting of the tracks by any person other than a judge is prohibited.

On the day the tracks are plotted, only the judges, AKC officials, judge applicants, apprentices with prior approval of the judges, and those required for the laying of the tracks will be allowed on the tracking field. All other persons connected with the test, such as exhibitors and owners or co-owners of an entered dog, must not be on the tracking field the day tracks are plotted. For each dog entered, a separate track will be plotted by one or both judges for a TD test and by both judges for TDX and VST tests one day prior to the test or earlier.

Section 5. Alternate Track. Judges are encouraged to plot an alternate track in case a retest of one of the dogs is required or in case one of the tracks becomes

invalidated. The alternate track should be fully equivalent to any other track so that it can be used promptly, saving time and permitting the test to proceed in an orderly fashion without interruption. The chart showing the plot of the alternate track should appear in the judges' books.

The priority for use of the alternate track is to replace a fouled track. When an unused alternate track is available, it may be used as a titling track, if agreed upon by both judges. The maximum number of tracks allowed by either judge to be judged in one day may not be exceeded. For an unused track to be used as a titling track, it must be plotted on the same day as all other tracks.

Section 6. Articles. Judges will approve all articles well in advance of the time the track is laid so that any article that is not acceptable can be replaced. The article(s) will have been in the tracklayer's possession for sufficient time to ensure that they are impregnated with the tracklayer's scent. All articles will be inconspicuous in color in comparison to the surrounding terrain. For article specifications refer to Chapter 3, Section 5 for TD; Chapter 4, Section 6 for TDX; and Chapter 5, Section 4 for VST.

The tracklayer will drop articles on the track. After being dropped, an article should not be visible from a distance of more than 20 feet and will not be covered with any substance to conceal it. Each tracklayer must prepare an extra start article and have it readily available in the event the start article is fouled or can not be located.

Section 7. Turns. A turn is a substantial and abrupt change in direction. Legs that gradually curve or meet in open angles that deviate only slightly from a straight line are not turns.

Section 8. Bitches in Season. Any bitch that appears so attractive to males as to be a disturbing element is considered to be in season.

Bitches in season may participate in a tracking test, at the test-giving club's option, under the following conditions:

1. The premium list specifically states that "BITCHES IN SEASON MAY PARTICIPATE."
2. The test secretary and judges are notified that a bitch(es) is/are in season prior to the drawing for tracks. The last track(s) to be laid will be reserved for the bitch in season. If there is more than one bitch in season, a second draw for these bitches will be held.
3. Bitches in season will be allowed to participate in a test only after all the other dogs and not-in-season bitches have been judged.
4. The test chairman is responsible for ensuring that bitches in season are allowed on the tracking field only immediately prior to their running.

In the event the handler of a bitch in season does not comply with the conditions above, the handler and dog will be excused from the test site and will have any awards from the test withheld.

The judges must notify the AKC of any infraction in the conditions above by noting the infraction on the inside covers of the judges' books. If the owner or handler violates the intent of this section at a second tracking test, the AKC may initiate action it considers appropriate.

Section 9. Drawing for Tracks. To determine the order of running for each participant, the test secretary, with one or both of the judges present, will assemble the participants just prior to starting time for a drawing by lot of the assigned

catalog numbers. Once the numbers have been drawn, they may not be exchanged, except under unusual circumstances and only with the judges' approval. Any such exchanges must be fully reported in the judges' books.

Any dog absent from the site at the scheduled time of the drawing will be marked "Absent" by the judges, if an alternate is present to draw. Alternates who are present will be selected to draw by the order on the alternates list. If no alternate is present, the dog may be marked absent by the judges at the scheduled time of drawing or the judges may designate the test secretary to draw for the absent dog(s). If the test secretary has drawn for the absent dog, the dog will be marked absent if it is not present in time for the running of its track. In the event of a multiple day test, the draw will be divided between the days. Entries scheduled to run each day will be drawn on that day.

If a dog is withdrawn or excused after the draw but before the dog starts the track, the next alternate present will run the track.

People cannot act as tracklayers for dogs if, within the past 30 days, they have boarded, laid a track for, or regularly trained the dogs whose tracks they are to lay. The tracklayer must not be a person with whom the dog has resided or a member of the household or a member of the immediate family of the dog's handler. The judges will determine the order in which the tracks are run and the number of each track.

The judges may modify the draw to meet the requirements of the tracklayer.

Section 10. Track Laying. Tracklayers must be present on the day of plotting and must walk their tracks. At least one cross-tracklayer will be present the day of plotting TDX tracks. When a tracklayer is not present, an explanation must be made in the test secretary's report. Tracklayers will wear their own footwear, which may be of any material.

It is the judge's responsibility to instruct the tracklayer so that each track will be properly laid. The judges will ensure that the tracklayer carries an outline of the track showing all pertinent feature information. One or both of the judges should make every effort, within the limitations of the judging schedule and terrain, to observe the tracklayer during the laying of the track.

The judges will instruct the tracklayer to walk in a natural manner. There should be no scuffing of the feet over any portion of the track, including the area at the starting flag or between flags. The tracklayer will go to the first flag, pause, and then proceed in walking the track. Circling the flag and scuffing feet around the flag is prohibited.

The tracklayer will pick up all but the first two flags in a TD test or all but the first flag and the cross-track flags in a TDX test. No other flags, except for the starting flag, may be used in a VST test.

After dropping the last article, the tracklayer will continue in a straight line for at least 30 yards as a continuation of the last leg of the track. The tracklayer should then proceed out of the field in the direction previously explained by the judges. In TD and TDX tests, no tracklayer may return within 50 yards of any unused part of a track after completing the track.

While it is not encouraged, if circumstances at a combined test require, a person entered in one test may lay tracks in another.

Section 11. Errors in Track Laying. Despite taking all precautions, there may be errors in track laying. If the tracklayer is aware of an error, it must be made

known to the judges as soon as possible. The judges will then decide whether use of the track meets the requirements of these *Regulations*.

Section 12. Retest. In unforeseen circumstances, the judges may in rare instances, at their own discretion, retest the dog and handler on a new track. The circumstances will be noted in the judges' books.

If, when the dog is working, the judges encounter a flag still standing in the field, the dog's performance must be evaluated in light of the likely route taken by the tracklayer. If the length of the track falls within the requirements of these *Regulations*, the judges must decide whether the tracking performance of the dog met the other criteria for awarding of a title or whether the dog should be retested on another track.

Section 13. Distractions on the Track. The judges are responsible for seeing that spectators remain farther than 50 yards from the starting flag until after the dog, handler, and judges have moved out of the starting area. The judges may authorize a member of the test committee to move spectators onto the area of the used track to observe the tracking field, so long as the spectators do not:

1. Interfere with the dog's work;
2. Indicate the location or direction of the unused portion of the track;
3. Contaminate unused tracks.

Should an animal, pedestrian, or vehicle appear or move across the track prior to running the track and/or while the dog and handler are working the track, the dog and handler will continue to work the track. Incidents such as these will be considered a normal occurrence for tracking tests. The judges will decide whether to invalidate the track.

Section 14. Leash, Harness, and Distance Between Handler and Dog. The leash will be between twenty (20) and forty (40) feet in length. The leash will be attached to the dog's harness while tracking. The dog must wear a harness while tracking. The harness will be constructed of straps of plain, pliable material and will be designed so that there is minimum restriction of the dog's movement. An inconspicuous marking is permitted on the harness to identify the dog in case of loss. If a collar is worn by the dog while tracking, the collar must meet the requirements of Chapter 2, Section 17 (Collars), of the *Obedience Regulations*. However, required licenses or rabies tags may be attached to the collar. The leash must show on top of the harness while tracking, and it must not be deliberately run through the underside of the dog, controlling or restricting the dog's movement.

The handler will follow the dog at a distance of no less than twenty (20) feet, except during the VST test where the handler may follow the dog at a distance of no less than ten (10) feet.

To avoid entanglement, the leash may be dropped briefly during the tracking test but must be retrieved as soon as possible. If the leash becomes entangled, the handler may unsnap the leash to free it. While the leash is being untangled, the dog must be under the immediate control of and in close proximity to the handler.

When tracking in dense vegetation, the handler may follow the dog at less than the required distances. The handler will return to following the dog at twenty (20) feet or more when the dog leaves the area of dense vegetation.

Section 15. Commands and Signals. Handlers may give verbal commands and verbal encouragement to the dog. However, commands, signals, or body

motions used by the handler to indicate the specific location or direction of the track are prohibited. Harsh verbal commands or physical force used to discipline the dog are also prohibited.

Section 16. Guiding and Restraining. Guiding is defined as behavior by the handler that influences or determines the dog's direction. Guiding is prohibited and will cause the dog to be failed.

Restraint is permitted to slow a dog that is moving too fast for the handler or in the event of an unusual distraction. However, repeated restraint that influences the dog's direction is not permitted and will result in the dog being failed. A dog that is at the end of the leash actively searching, including casting, should not be considered as being restrained.

Section 17. Assistance to Handler. Neither the judges nor any other person may give the handler any assistance in determining the direction of the track. However, this does not preclude judges from advising exhibitors of a sudden or potentially dangerous situation. Judges will not answer exhibitors questions relative to whether they are on the track, whether they have picked up a legal or extraneous article on the track, or whether an article may be missing; exhibitors are to read and work with their dogs on their own.

Section 18. Carrying Water on the Track. The handler may carry plain water or ice on the track and may provide it to the dog for drinking or use it to cool the dog. The use of any liquid other than plain water requires the dog to be failed and excused from the tracking test.

Section 19. Food and Other Motivational Items on the Track. Praise and petting of the dog are allowed after the dog finds the article(s). However, exhibitors will not excessively play with articles as toys, toss them to the dog, or throw them on the ground, which may be construed as a restart.

The only items permitted on the tracking field are those items considered by the judges to be essential to the conduct of the test, and permitted by these *Regulations*. Judges will not allow motivational items for a dog, including but not limited to food, balls, or toys, to be used or carried within 75 yards of any track. The carrying or use of food or other motivational items for the dog by the handler on a track requires that the dog be failed and excused from the tracking test.

Section 20. Time Limit. There is no time limit for completing the track, but a dog that is not working should not be given any minimum time and should be marked "failed".

Section 21. Fouling the Track. A dog that fouls the area during the running of a track will not be failed for that reason alone.

Section 22. Judges' Books. Either the judges' field charts or the official AKC charts are to be marked, one by each judge, at the time the dog is tracking. If a field chart is used by a judge, all pertinent information will be transferred in its entirety to the official charts as soon as practicable. The official charts measure 8-1/2 by 11 inches and will show the following information:

1. A plot of the track including the length in yards (to be circled) of each of the legs and the total length of the track. The plot on the chart should be generally proportional to the track in the field.

2. A broken line showing the approximate path of the dog. (May be in red ink.)
3. The time the tracklayer started.
4. The time the dog started and finished the track.
5. A brief description of the terrain.
6. An arrow showing the direction of the wind at the start.
7. A brief description of weather conditions.
8. Indication of steep hills and valleys.
9. All pertinent landmarks and markers used to locate turns.
10. Each judge will sign the chart and will indicate the dog's catalog number, AKC registration number, and whether the dog passed or failed.

A passing performance requires the agreement of both judges. It would be highly irregular for one judge to consider a dog "Passed" while another marked it "Failed." If this occurs, the dog should not pass the test. In this case, a written report explaining the circumstances for the decision would be required from each judge by the AKC.

In the event that one of the judges is injured or otherwise unable to continue judging a tracking test, the test secretary and the Event Committee will select a knowledgeable person to assume that judge's duties. The co-judge will instruct the replacement judge as to the layout of the tracks and all other information needed for the completion of the test.

No person other than the judges will make any entry in the judges' books. Duplicate copies of the judges' books will be made available through the superintendent or test secretary for examination by the owners and handlers immediately after the tracking test. Handlers will receive and keep a copy of their charts from each judge. Each judge will receive a marked copy of the catalog or sheet listing the entered and alternate dogs at the completion of the test.

After a licensed or member tracking test, the club or tracking test secretary will forward copies of the judges' marked charts, a list of all dogs that were entered, the complete list of alternates drawn, and a marked and certified copy of the catalog pages or sheet listing the dogs entered in the tracking test to the AKC. These materials must reach the AKC offices within seven (7) days of the test's completion.

Section 23. Passing Performance. It is the judges' responsibility to determine whether the nature and degree of the handler's and dog's work met minimum requirements to earn a tracking title. The dog must follow the track and either clearly indicate or retrieve the last article in a TD test or clearly indicate or retrieve the second, third, and fourth articles in a TDX or VST test. The decision as to whether the dog satisfactorily indicated or retrieved an article is the responsibility of the judges. In order for the dog to pass a TD test, the last article must be presented to the judges when the track is completed. In a TDX or VST test, the second, third, and fourth articles must be presented to the judges when the track is completed.

Judges must never pass a dog that has not met the minimum requirements of following the test track unaided and finding the article(s). If the dog is not considered to be tracking by the judges, it will not be passed, even if it finds the article or articles.

If, in the judges' opinion, the dog actively searched the area where an article was dropped but did not find the article, and the judges cannot find the article, the dog

will be given credit for finding the article. The foregoing only applies to TD and TDX tests. For VST see Chapter 5, Section 5.

In the event that the dog does not actively search the area and the judges cannot find the article, the dog will be tested on another track that meets the requirements of these *Regulations*.

Section 24. Protective Clothing. Dogs may wear a protective coat, providing both the coat and tracking harness are put on in the presence of both judges.

CHAPTER 3

Tracking Dog Test

The fundamental features of a TD test are the dog's ability to follow a track laid by a person under a variety of conditions on moderate terrain and to find an article dropped by that person at the end of the track.

Section 1. Eligibility. This test will be for dogs not less than six (6) months of age that are eligible for entry and that meet the requirements of the following Section 2.

A dog may continue to participate in this test after it has earned the titles TD, TDX, or VST. Dogs not holding a Tracking Dog title will be given priority for entry in the test by the tracking test secretary. A statement to this effect will appear in the premium list.

Section 2. Certification. A written statement must accompany each entry for a licensed or member tracking test for any dog that has not previously passed an AKC TD test. This statement must be dated within one year of the date the test is to be held, signed by a person approved to judge tracking tests, and must certify that the dog has satisfactorily performed a certification test.

The certification test will be of a complexity equivalent to the TD test and will take place under conditions similar to such a test. A dog that does not satisfactorily complete the certification test in its entirety will not be certified.

A dog that fails a tracking test may not be re-certified by one of the judges based on its performance at that test, regardless of how close the dog came to passing.

It is permissible for a dog to be entered under the certifying judge.

Judges who wish to enter a TD test are subject to the same requirements as other entrants. Judges will not provide certification to any dogs they own wholly or in part.

The certification statement signed by a provisional or approved tracking judge should be worded similarly to the following:

"I have observed the tracking performance of (registered name, AKC registration number, breed) on a track of equivalent complexity and under conditions similar to a regulation AKC tracking test (TD). I hereby certify that the dog performed the certification test in its entirety and is ready to participate in an AKC licensed or member tracking test."

1. Date of certification test;
2. Original signature of judge;
3. Judge's typed or printed name;

4. Judge's number.

The judge will provide four (4) certification statements based on the dog's completion of one certification test. Should the dog fail at four (4) successive licensed or member tracking tests within the twelve (12)-month period, the dog must be recertified in order to be eligible to enter additional licensed or member club tracking tests.

The statements certifying the dog's ability to follow a track must be originals. They cannot be used again, and they must be retained by the test-giving club with the entry forms.

In unusual circumstances, the AKC, through its Companion Events department, may issue tracking certifications based on statements provided by the handler concerning the dog's tracking ability.

Section 3. Tracking Dog Title. The AKC will issue a Tracking Dog certificate and will permit use of the letters TD after the name of each dog certified by two judges to have passed a licensed or member club TD test, a combined TD/TDX test, a combined TD/VST test, or a TD/ TDX/VST test.

As soon as a dog has been certified by the judges as passing a licensed or member TD test, it may be entered in any licensed or member TDX or VST test for which the entries have not closed.

Section 4. Track Requirements. The following are the restrictions and minimum requirements for a TD track:

1. The track must be at least 440 yards and not more than 500 yards in length.
2. The length of each of the legs of the track must be at least 50 yards.
3. The scent on the track must be not less than thirty (30) minutes or more than two (2) hours old.
4. A total of three (3) to five (5) turns must be used. Both left and right 90-degree angle turns must be used. No acute angle turns are to be used. The first turn must be at least thirty (30) yards from the second flag.
5. At least two (2) of the turns must be 90-degree turns, and there should be more than two (2) such turns.
6. At least two (2) of the 90-degree turns will be well out in the open, where there are no fences or boundaries to guide the dog.
7. No part of the track will follow any fence or boundary within 15 yards of such fence or boundary.
8. No part of the track may be within 50 yards of any other part of the same track.
9. Consecutive parallel tracks may not be used.
10. No part of any track may be laid within 50 yards of another track.
11. A track will not cross a body of water or a paved road. Tracks may be plotted that cross sidewalks and bike and jogging paths. These paths should not be more than approximately six (6) feet in width. No TD track should have changes of cover that would be suitable for a TDX obstacle. No conflicting cross-tracks will be used.
12. Tracks may be plotted to allow passage from one field to another through an opening in a hedgerow. The cover in said opening should be about the same as the surrounding area with no heavy undercover, brush, or logs. There will not be a turn less than thirty (30) yards before or after passing through the hedgerow opening.

If, because of the terrain, the judges are unable to plot a track that meets all requirements for a TD test, an explanation of the circumstances must be reported in the judges' books.

Section 5. Article for a Tracking Dog Test. Chapter 2, Section 6, sets forth the criteria for articles. The start article must be made of cloth and must be the approximate size of a glove or wallet. In a TD test, the last article will be a glove or a wallet.

Section 6. Start. The start will have a flag at the beginning and a second flag 30 yards from the first flag indicating the direction of the first leg.

The tracklayer will begin at least ten (10) yards from the starting flag, lining up with the starting flag and the second flag. The tracklayer will proceed along this line ensuring there is no turn at the starting flag. While walking this line, the tracklayer will pause momentarily at the first flag, drop the start article, then continue walking the track in the manner specified in Chapter 2, Section 10. The start article must be made of cloth and must be the approximate size of a glove or wallet. The handler may pick up the article at the starting flag and use it to give scent to the dog while on the track.

The test begins when the dog leaves the first flag. The initial 30 yards between the flags is part of the track; all requirements for the track apply. In this portion of the track, the handler may restrain the dog, but any leading or guiding of the dog constitutes grounds for calling the handler off the track and failing the dog. Provided the dog has not passed the second flag, the handler may request permission from the judges for a restart. If approved by the judges, the handler may restart the dog, either from their present location or after returning to the starting flag. Only one restart is permitted.

CHAPTER 4

Tracking Dog Excellent Test

The fundamental feature of a Tracking Dog Excellent test (TDX) is to show unquestionably that the dog has the ability to discriminate scent and possesses the stamina, perseverance, and courage to do so under a wide variety of conditions.

A TDX test presents difficult challenges. Judges are to plot tracks as challenging and realistic as the terrain will permit, while maintaining proper concern for the safety of the dogs and handlers.

Section 1. Eligibility. The TDX test is for dogs that have earned the TD title. A dog may continue to participate in this test after it has earned the TDX title. However, the tracking test secretary will give priority to entries for dogs that do not hold a TDX title. A statement to this effect will appear in the premium list.

Section 2. Tracking Dog Excellent Title. The AKC will issue a Tracking Dog Excellent certificate and will permit the use of the letters TDX after the name of each dog that has been certified by two judges to have passed a licensed or member club TDX, a combined TDX/VST, a combined TD/TDX, or a combined TD/TDX/VST.

Section 3. Track Requirements. The following are the restrictions and minimum requirements for a TDX track:

1. The track must be at least 800 yards and not more than 1,000 yards in length.
2. The length of each of the legs of the track must be at least 50 yards.
3. The scent on the track will not be less than three (3) hours or more than five (5) hours old.
4. A total of five (5) to seven (7) turns must be used. Both left and right turns must be used. The first turn will be in an open area.
5. Acute angles should never be used, except in unusual circumstances when terrain dictates. A turn whose angle is severely acute may not be used.
6. At least three (3) turns will be 90-degree turns, and there will be both left and right 90-degree turns.
7. No part of the track may be within 50 yards of any other part of the same track.
8. No part of the track may be within 50 yards of any other track.
9. Cross-tracks — See Section 4 of this Chapter.
10. Obstacles — See Section 5 of this Chapter.
11. Articles — See Section 6 of this Chapter.

If, because of the terrain, the judges are unable to plot a track that meets all requirements for a TDX track, explanation of the circumstances must be reported in the judges' books.

Section 4. Cross-Tracks. Upon instruction from the judges, two (2) cross-tracklayers will lay the plotted cross-tracks at least 1 hour and 15 minutes, but not later than 1 hour and 45 minutes, after the tracklayer has started laying the actual test track.

The cross-tracklayers will walk side-by-side, about four (4) feet apart and will follow each of the two (2) cross-tracks that were staked out with flags a day or more earlier, collecting all the cross-track flags along the way.

The cross-track flags or markers will be distinctly different from the flags or markers used on the actual test track.

The following restrictions and minimum requirements apply to all cross-tracks:

1. The track must be crossed at two (2) widely separated places, never on the same leg or on the first leg.
2. The cross-tracks will be located in full view of the judges when following the track.
3. The actual track should be crossed at an approximate 90-degree angle.
4. The cross-tracks will be at least 30 yards from an article or an obstacle and at least 50 yards from a turn.
5. The path of the cross-tracks will be plotted to permit the dog to follow the cross-track for at least 30 yards without the interference of a physical barrier or a scenting distraction.
6. The path of the cross-tracks must be at least 75 yards from the start of the track and must be at least 50 yards from any other part of the track, except when they cross the track.
7. The cross-tracklayers will proceed 50 yards in a straight line before the first crossing of the track and will proceed 50 yards straight ahead after the last crossing of the track.
8. The cross-track may not be within 50 yards of any other track.

In a TDX test, a dog that follows a cross-track for more than 50 yards will be failed.

Section 5. Obstacles for a Tracking Dog Excellent Test. There will be at least two (2) obstacles to challenge the dog and handler. Obstacles will be separated from articles and cross-tracks by at least 30 yards. A turn may be within 30 yards of an obstacle. There will be no obstacle on the first leg.

The purpose of an obstacle is to test one or more of the following:

1. The dog's ability to adapt to changing scent conditions;
2. The dog's ability to continue scenting while overcoming physical obstacles; and
3. The dog's ability to continue scenting under difficult and varied handling conditions.

Various types of terrain and cover, including gullies, plowed land, woods, and vegetation may be used. Natural obstacles, such as streams, or man-made obstacles, such as fences, bridges, or lightly traveled roads may be used.

The judges' charts must clearly indicate the obstacles used in the test.

Section 6. Articles for a Tracking Dog Excellent Test. The criteria for articles as contained in Chapter 2, Section 6, apply. The TDX test articles will consist of four (4) personal, dissimilar articles, about the same size as a glove or wallet, that are to be dropped on the track by the tracklayer at the points indicated on the judges' charts. Only the last article may be a glove or a wallet.

The first article will be dropped at the starting flag and will be clearly visible to the handler. The next two (2) articles will be dropped at wide intervals directly on the track at the places designated by the judges and marked on the chart. The fourth article will be dropped at the end of the track.

Articles will be dropped at least thirty (30) yards from a turn, an obstacle, or a cross-track.

Section 7. Start. The start will have one flag in an area that permits the direction of the track to begin in a 180-degree arc. The tracklayer will begin at least thirty (30) yards from the starting flag, lining up with the starting flag and the next flag. The tracklayer will proceed along this line, assuring there is no turn at the starting flag.

While walking this line, the tracklayer will pause momentarily at the first flag, drop the first article, and continue walking the track as specified in Chapter 2, Section 10.

The judges, at a distance of about 50 yards from the starting flag, will instruct the handler as to the location of the starting flag. The judges will direct the handler to the starting flag but will not indicate the direction of the track. The angle between the handler's direction of approach and the tracklayer's direction of approach will be less than 90 degrees.

At the start of the track, the dog will be given ample time to take the scent and begin tracking. The handler may use any method as long as no force, guidance, or roughness is used to start the dog at the first flag of the test. Since there is no second flag in this test, the handler must wait for the dog to commit itself before leaving the starting flag. Once the dog has left the starting flag, the test has begun, and no restart is permitted.

The handler may pick up the article at the starting flag and use it, as well as

subsequent articles, to give scent to the dog while on the track.

Section 8. Aiding of the Dog. The dog may be physically assisted by the handler when obstacles, barriers, or terrain so require.

Section 9. Judges' Books. The charts should be marked, one by each judge, as in a TD test and should include the following additional information:

1. The time the cross-tracklayers started;
2. The location and description of the articles used;
3. The location and description of the obstacles used;
4. The location and direction of the cross-tracks;
5. Each change of terrain and its length in yards.

CHAPTER 5

Variable Surface Tracking Test

The Variable Surface Tracking Test is a test of credibility, verifying the dog's ability to recognize and follow human scent while adapting to changing scenting conditions. The test is to be as practical as possible while demonstrating the dog's willingness and ability to follow a specific scent given to the dog at the start of the test. The training and conditioning of the dog must be designed to develop the inner drive, motivation, and determination necessary for the dog to work with intensity and perseverance. The dog must show ability to work on a non-vegetated surface.

Judges are encouraged to permit spectators to follow along on the track, at a distance that does not interfere with the working of the dog. A "guide" may be appointed to control the gallery. The dog must show ability to work on a non-vegetated surface.

Section 1. Eligibility. The Variable Surface Tracking Title (VST) is for dogs that have earned the TD or TDX title.

A dog may continue to participate in this test after it has earned the VST title. However, the tracking test secretary will give priority to entries for dogs that do not hold a VST title. A statement to this effect will appear in the premium list.

Section 2. Variable Surface Tracking Test. The AKC will issue a Variable Surface Tracking Dog certificate and will permit use of the letters VST after the name of each dog that has been certified by both judges to have passed a licensed or member club Variable Surface Tracking test, a combined TD/VST, a combined TDX/VST, or a combined TD/TDX/VST.

Section 3. Track Requirements. The following are the restrictions and minimum requirements for a variable surface track:

1. The track will be at least 600 yards and not more than 800 yards in length.
2. The track will have a minimum of three (3) different surfaces, which will include vegetation and two (2) areas devoid of vegetation, such as concrete, asphalt, gravel, sand, hard pan, or mulch. The areas devoid of vegetation will comprise at least one-third (1/3) but not more than two-thirds (2/3) of the total length of the track.
3. The length of each of the legs of the track will be at least thirty (30) yards. Parallel legs will not be within fifty (50) yards of each other unless a contiguous building or structure physically blocks access between the parallel

legs. (Note: No part of the track may be within thirty (30) yards of any other part of the same track.)

4. The track will be plotted using different surfaces and scenting conditions as afforded by the terrain. There will be no physical obstacles or obstructions such as those used on a TDX track. The level of physical difficulty should be such that it will permit all AKC breeds and handlers of any age to participate. Ordinary stair steps are not considered to be an obstacle, but a wall or fence that must be climbed or scaled is an obstruction that must be avoided.
5. The scent on the track will be not less than three (3) hours or more than five (5) hours old.
6. Turns will be on various surfaces as dictated by the terrain. There will be at least four (4) and not more than eight (8) turns on a track. Deviations in a confined stairway or corridor will not count as one of the required turns. Both right and left 90-degree turns will be used. At least three (3) of the turns must be 90-degree turns, and there should be more than three (3) such turns. At least one (1) moment of truth 90-degree turn will be in an area devoid of vegetation and will be plotted to allow at least thirty (30) yards before crossing or returning to a vegetated surface. Acute angle turns should be avoided. Articles will not be placed less than thirty (30) yards before or after this turn. Articles placed after this turn should not be clearly visible from the turn. Tracks may be laid along the sides of buildings and fences, through buildings with two or more openings or open-sided structures, such as breezeways, shelters, or roofed parking garages. However, tracks may not enter a building with closed doors and sides.
7. No part of the track will be within fifty (50) yards of any other track. No part of the track may be within thirty (30) yards of any other part of the same track.
8. All tracks will be laid utilizing buildings and the diverse scenting conditions created by being in close proximity to such buildings. Tracks will also utilize any and/all other structures such as fences, breezeways, ramps, stairs, bridges, shelters, roofed parking garages, courtyards, and buildings with two or more openings and/or open buildings. The intent of Variable Surface Tracking stresses that dogs will be able to handle the diffusion of scent created by these structures. Tracks will be as equal in complexity as possible in this regard. Tracks may not enter a building with closed doors and sides.

Section 4. Articles for Variable Surface Tracking Test. Chapter 2, Section 6, sets forth the criteria for articles. The VST test articles will consist of four (4) dissimilar, common, everyday items that can be easily carried by the tracklayer and safely picked up by the dog. Each article will not be smaller than 2" x 4" or larger than 5" x 5" and will weigh no more than 8 ounces and may be weighted in place when wind conditions warrant. There will be one leather, one plastic (rigid or semi-rigid), one metal, and one fabric article, which will be handled by the tracklayer and will be dropped on the track by the tracklayer at the points indicated on the judges' charts.

The first article will be fabric or leather. The last article will be clearly and temporarily marked with the number "4."

The first article will be dropped at the starting flag and will be clearly visible to the handler. The next two (2) articles will be dropped at wide intervals directly on the track at the places designated by the judges and so marked on the chart. One article must be dropped in one of the areas devoid of vegetation. The fourth article

will be dropped at the end of the track.

The articles must be approved by the judges prior to the laying of the track. The second, third, and fourth articles must be presented to the judges by the handler following the completion of the track.

No article will be dropped less than twenty (20) yards from a turn except as indicated in Section 4, #6.

The judges will mark a dog "Passed" if an article is not found and cannot be located by the judges or the tracklayer, provided that the dog worked continuously and intently along the actual track. Should a dog find additional articles along the track, the dog will not be failed and will be permitted to continue.

Section 5. Start. The start and the first twenty (20) yards of the track will be in an area of vegetation and will have one flag at the beginning that permits the track to go in one of several possible directions within a 180-degree arc whenever possible. The tracklayer will begin at a point about 30 yards from the starting flag, lining up with the flag in the direction of the first leg. The tracklayer will then proceed along this line assuring there is no turn at the starting flag.

While walking this line, the tracklayer will pause momentarily at the starting flag, drop the article, and continue walking the track as specified in Chapter 2, Section 10, of these *Regulations*.

At about thirty (30) yards from the starting flag, the judges will instruct the handler as to the location of the starting flag. The judges will direct the handler to the starting flag but will not indicate the direction of the track. The angle between the handler's direction of approach and the tracklayer's direction of approach will be less than 90 degrees.

At the start of the track, the dog will be given ample time to take the scent and to begin tracking. The handler may use any method provided no force, guidance, or roughness is used to start the dog at the starting flag. Since there is no second flag, the handler must wait for the dog to commit itself before leaving the starting flag. Once the dog has left the starting flag, the test has begun; no restart is permitted.

The handler may pick up the article at the starting flag and use it, as well as subsequent articles, to give scent to the dog while on the track. The handler will work no closer than 10 feet from the dog.

The judges may post a person or persons at a suitable distance from the track to observe the tracklayer and/or handler and warn them of potential problems, such as moving vehicles, cyclists, etc. The handler, judges, or assigned person(s) may stop the dog at any time for safety purposes. The handler and dog will resume tracking when the danger has passed.

Section 6. General Requirements.

1. Plotting an alternate track is not required.
2. Both judges must walk every track and plot all tracks together.
3. A previously used track may not be run forward or backward within three (3) days of use.
4. The same tracklayer may not be used on contiguous tracks. A tracklayer may cross an adjacent track in order to exit the field on test day, provided the track being crossed was not laid by the tracklayer or a member of the tracklayer's household.
5. For the safety of the dog and handler, judges must be aware of surface temperature in hot weather, especially on asphalt and concrete. Tracks must

not be run on surfaces where the judges and/or Event Committee have knowledge of recent treatment with chemicals that could cause injury to the dog or handler. If conditions are unsafe for the dog or handler, or in the event of an unforeseen emergency, the test secretary and the Event Committee, upon the recommendation of the judges, may extend the duration of a Variable Surface Tracking test by one day or more within a fifteen (15)-day period after the original date, provided that the change of date is satisfactory to the majority of the handlers of entered dogs. If a satisfactory date cannot be agreed upon, the test will be canceled.

6. A Variable Surface Tracking site totally or partially covered in snow would not meet the criteria of three (3) different surfaces including vegetated and non-vegetated surfaces. Snow-covered portions of a site may seriously affect the proper utilization of the site as a whole.
7. All other general tracking regulations apply to the Variable Surface Tracking test.

Section 7. Judges' Books. Judges will indicate on the charts each change of terrain and its length in yards. Judges will make a specific notation next to each length of yards to indicate the type of surface. Notations may be abbreviated, such as BT for black top, C for concrete, G for grass, M for mulch, etc., provided the judges explain such notations at the bottom of their chart. Judges should include in their charts the buildings, fences, roads, breezeways, bridges, and/or any other major structures in relationship to the track that affects the movement of scent on the track.

CHAPTER 6

Champion Tracker Title Certificate

Champion Tracker Title Certificate. The AKC will issue a Champion Tracker certificate and will permit the use of the letters CT preceding the name of each dog that has earned all three tracking titles: TD, TDX and VST.

TRACKING TEST AND JUDGES GUIDELINES

These guidelines reflect the policies and practices set forth by the AKC Board of Directors. Judges are expected to conduct themselves in accordance with the guidelines. Failure to comply with these guidelines subjects a judge to disciplinary action.

Tracking is a team sport in the truest sense. In true team effort, a handlers working as teams with their dogs exhibit a real understanding of the dogs' motivation and commitment to the task at hand. Handlers are able to read their dogs and communicate with them to accomplish their goal. It is the responsibility of the judges to differentiate between team cooperation and guiding by the handler and to determine when the handler is no longer a supporting member of that team and is attempting to guide the dog. In Variable Surface Tracking, team effort becomes even more critical due to the nature of the test. The objective of a Variable Surface Tracking test is proving credibility in following a scent in an urban locale. The dog works for the sheer love of scenting.

The tracking fraternity is known for its friendliness, hospitality, and encouragement of all participants. Tracking judges are members of a very select group. Each judge represents the AKC at tracking tests. Judges are expected to maintain the high standards that have been set for holders of the titles TD, TDX, and VST. At the same time, a judge should endeavor to make the tracking test itself a pleasurable event for dogs, handlers, spectators, and the club sponsoring the event. Adherence to the principles provided in the tracking regulations and the guidelines will enable judges to achieve these goals.

Although there is no restriction on handlers entering dogs under judges they have trained with, extreme care should be taken to ensure impartiality. There is no room for even the suggestion that anything other than the work of the dog is involved in a judge's decision. You must possess and project an unwavering air of integrity and ethical behavior that maintains the reputation of AKC. Judges are presumed to be honest, competent, and dedicated. Nevertheless, judges may find themselves in uncomfortable or even inappropriate situations. These guidelines cannot cover every situation. They can, however, help a judge avoid improprieties or perceived improprieties. Some ethical rules are clear. For example:

1. Never solicit or promote assignments.
2. Never accept any payments or presents for past or future placements.
3. Advise potential exhibitors not to enter under you when their presence or the presence of their dogs might give the impression of unfair advantage, such as a person with whom you own dogs, wholly or in part; your employer; your employee; or a relative.

These are only examples. The key is to avoid situations that might give the impression of impropriety.

The AKC recognizes you cannot control who enters. This does not diminish the importance of appearances. Everything possible must be done to keep your reputation as an AKC judge above reproach.

Section 1. Assignments. A tracking assignment entails a two (2)-day commitment by the judges. Acceptance of an assignment means that if the test is on a Saturday, the judges will be available to plot tracks the day before. Similarly, a Sunday test will involve the judges for both days of the weekend. No judges will accept assignments that require more in one day than they are physically and

mentally able to accomplish. No judges will exhibit in any events or competitions until completion of their two-day assignments.

Section 2. Assignment Limitation. Provisional Tracking Dog or Tracking Dog Excellent judges are required to judge with at least three (3) different approved regular status judges, only one of which may be a spouse. Provisional Variable Surface Tracking judges are required to judge their provisional assignments with at least three (3) different approved regular status Variable Surface Tracking judges, none of whom may be a member of the provisional judge's family or immediate households.

Section 3. Physical Fitness. A tracking test entails two (2) days of extensive walking over varied terrain. Tracking judges must be physically fit. Variable Surface Tracking may not require as much physical effort as TD or TDX tracking but may require more consideration of complex scenting conditions in an area containing buildings and/or other large physical structures, as well as a variety of tracking surfaces other than vegetation. No judge should accept an assignment with the assumption that the co-judge will do most of the physical work.

Section 4. Attire. Tracking tests are outdoor events subject to all varieties of weather. Tracking judges should be prepared with suitable outdoor gear for inclement conditions.

Section 5. Weather. In the event of an "unforeseen emergency" (severe weather or lightning could be considered in this category), a tracking test may be postponed. Judges, the test secretary, and the Event Committee must consider the difficulty a postponement would pose for the entrants who may have traveled great distances to the event. Postponement could pose problems for the test-giving club as well as for the judges.

A normal rainstorm is not considered sufficient justification for delaying laying a track or conducting a test. A sudden torrential cloudburst or lightning could be justification for a retest on another track, if the scent of the original track, in both judges' opinions, was completely washed out. Similarly, a cloudburst could delay laying a track.

Section 6. Visible Tracks. Snow, frost, dew on the fields, plowed ground, or a visible path on any other vegetated or non-vegetated surface, such as in a VST test, creates the possibility that the path of the tracklayer may be evident to the dog and handler. Judges must consider whether awarding a title to a dog under these circumstances would render a disservice to all previous title holders who have truly earned their titles. If the judges decide to proceed on any field or Variable Surface Tracking area where the track is visible, they must be alert to any attempts by handlers to lead their dogs. Any indication of guidance by the handler will cause the dog to fail. It is especially critical in VST that there are three (3) different surfaces available and that these surfaces are not obscured by a covering such as snow. Otherwise, the intent of VST will not be met.

Section 7. Use of Tracking Area. The most frequent problem confronting tracking judges is clubs' underestimation of the space required for an AKC regulation track. Judges must resist any pressure to accept too small an area. The statement, "We handled 'x' number of tracks in this one field or Variable Surface Tracking area last year," should not influence the judges. At the same time,

valuable tracking space should not be wasted, and judges must make every effort to utilize all available terrain to its best possible advantage.

In Variable Surface Tracking, judges, exhibitors, spectators and test-giving clubs should be aware that these areas may be heavily used by the general public and, accordingly, must make every effort to cooperate with these public areas and the people who use them in order to ensure that these Variable Surface Tracking sites will continue to be available for future tests. Clubs and exhibitors alike must try to confine “exercise areas” for dogs to a small designated area and be sure that those areas are cleaned up before the test is over. Clubs and exhibitors will be sure to leave the area in the same condition it was at the start of the test, not only to promote responsible dog ownership but to promote good relations with the general public.

In the case of Variable Surface Tracking, for the safety of the dog and handler, judges must be cognizant of surface temperatures in hot weather, especially on asphalt and concrete. Tracks will not be run on surfaces where the judges and/or tracking committee have knowledge of recent treatment with chemicals that might cause an injury to the dog and handler. If conditions are such as to be unsafe for the dog and handler, the test will be delayed, postponed, or canceled. A complete report of unsuitable grounds or lack of sufficient areas in which to plot the tracks will be made to the AKC by the judges in the Judges’ Books.

Section 8. Club Responsibilities. It is the responsibility of each test-giving club to furnish the following:

1. Transportation for the judges to and from the tracking area.
2. A more than adequate supply of tracking flags of sufficient height so as to be visible to tracklayers in the existing ground cover. There should be different colored flags for the successive numbered tracks and cross-tracks to eliminate any possibility of error. More than one mallet should be available to drive the flags firmly into the ground. This provision will not be applicable to Variable Surface Tracking, since only a starting flag is to be used.
3. Adequate manpower to assist the judges.
4. A tracking area that can easily accommodate the number of entries in the test. The area must also meet the requirements of these *Regulations* as to terrain; keep in mind the requirement for non-vegetated surfaces in Variable Surface Tracking.
5. Judges’ books.
6. A map of the tracking area.

If there is any question concerning the sufficiency of land to handle the entry or of suitability of the terrain, the judges should conduct an overall survey of the tracking area before plotting.

Section 9. Length of Stride. All tracking judges should determine the length of their strides when walking normally. A judge should be able to easily convert each step into yards or parts of a yard. Judges should check the length of their strides as part of the preparation for plotting tracks. Judges should be aware that there could be a difference in depth perception in plotting VST vs. TD or TDX because of the differences between developed and natural areas.

Section 10. Handler’s Responsibility. Handlers have the responsibility to train and prepare their dogs for the variety of terrain and conditions they may encounter in a tracking test. It is essential for handlers to realize that obstacles are

an important characteristic of the TDX test. Handlers should train their dogs to work through obstacles of varying difficulty.

Although there are no physical obstacles in VST such as those in TDX, handlers must train for all types of conditions and surfaces, including diverse scenting conditions. Conditions commonly found in a Variable Surface Tracking area may include soft and hard dirt, blacktop, concrete, paving materials, sand, gravel, wood chips, or metal stairs.

Section 11. Judges' Responsibility for VST Plotting. To further establish credibility, articles used in Variable Surface Tracking represent items made of substances used in everyday life that an average child or adult might carry and drop.

After the starting article of leather or fabric, judges should make every effort to place the remaining articles in varying random order on all tracks. Judges should not use standardized articles so that handlers do not look for only certain articles or a definite sequence of articles.

Article 2 or 3 should be dropped on a non-vegetated surface. This does not preclude the track from ending on a non-vegetated surface or the final article from being on a non-vegetated surface.

The last article should be temporarily marked with the number 4, such as with a small post-it note cut down in size, but NOT with any permanent markers or grease-type pencils. Articles should not have any rough edges or protruding parts that might cause injury to the dog.

When determining placement of articles on the track, judges should keep in mind the possibility that under certain wind conditions and circumstances an article placed on a minimum-length leg (30 yards) connecting two parallel legs might be easily bypassed by the dog, causing the dog to fail. Judges are discouraged from placing articles in such fashion as to fail dogs. Judges should also use caution when placing articles in or near buildings and structures when there is a strong possibility that the dog might cut off that portion of the leg that the article is on.

Judges should keep in mind that Variable Surface Tracking does not contain obstacles, and no non-vegetated surface in itself should constitute an obstacle for a dog. Anything on the track that prohibits any AKC breeds of dogs and handlers of all ages from participating might be construed as an obstacle.

Tracks for VST will be laid utilizing any and all structures on site and the diverse scenting conditions provided by such structures, such as buildings, fences, breezeways, ramps, stairs, bridges, shelters, roofed parking garages, courtyards, and buildings with two or more openings, and/or open-sided buildings. The intent of Variable Surface Tracking stresses that dogs will be able to handle the diffusion of scent created by these structures. Tracks will be as equal in complexity as possible in this regard. Judges will not avoid plotting tracks in close proximity to buildings when they are available, if it is feasible to do so and will ensure a track that meets the intent of Variable Surface Tracking. Judges will not plot tracks utilizing only one small shed-type building or single fence line when the above options are available to plot fair but challenging tracks.

Judges will not use the 90-degree non-vegetated turn in such a way as to be influenced by vegetation. In fact, the turn will be a true moment-of-truth, non-vegetated turn.

Judges are to avoid plotting tracks only in open areas, thereby preventing VST tracks from becoming elongated TD tracks. For safety purposes, judges are prohibited from crossing heavily traveled roads.

Variable surface tracks should be as realistic as possible. Keep in mind that most people will follow the path of least resistance. Lost adults are drawn to buildings to seek help, while lost children may be drawn to playgrounds.

Only contamination of a track by a hazardous material or a large portion of a track being rendered unusable will warrant laying another track. People, animals, or vehicles crossing a track will not invalidate that track.

Judges should be aware that in a Variable Surface Tracking area, there might be an overabundance of similar landmarks. Similar landmarks, such as grassy islands that look the same, yellow-line dividers in parking lots, and other repetitive landmarks, can easily cause confusion since no flags are used in Variable Surface Tracking.

It is not necessary that the judges' charts be drawn to scale. However, every effort should be made to indicate the location of buildings, structures, etc., in relation to the general area in order to provide a complete picture of the track in question. Judges are not expected to be artists when indicating buildings and/or structures in the preparation of their charts.

Section 12. Position of Judges During Test. While it is possible to see an entire track from a single vantage point, it is virtually impossible to evaluate a marginal or failing performance from this same single or stationary point. It is also unfair to dogs and their handlers. Distance can distort the precise location of turns. Anyone can pass a dog that unhesitatingly executes every turn and, nose down, tracks perfectly and finds the article(s). Judges are needed for the evaluation of the imperfect performances.

To ensure that the dog and handler are on the track, it is essential that the judges follow the dog and handler at a discreet distance. A recommended position for evaluating the performance is on the leg of the track just completed. In the case of a very long leg, a position about 40 to 50 yards behind the handler works well. If the handler and dog cannot be observed, due to terrain or dense vegetation, the judges may move closer to observe the handler and dog.

The judges should confine their positions to a completed portion of the track. By walking into a still-unused part of the field, the judges show the handler that a track cannot go into this area. Also, judges who move only when the dog is moving in the correct direction may indicate the direction of the track to the handler.

In Variable Surface Tracking, the scent cone varies widely from those in TD or TDX due to buildings, structures, etc. It is imperative that when judging, the judges follow the dog at a distance in order to be able to observe the dog tracking and allow the dog adequate time and distance to work out scenting problems, but not so close as to interfere with the dog while working. A judge should only fail a dog when it can no longer recover.

It is imperative that the judges not allow the tracklayer to follow so closely as to interfere with the dog and handler or create scenting problems such as causing the dog to turn and go directly to the tracklayer. However, the tracklayer should be in an area easily accessible to the judges if and when needed.

Section 13. Evaluation of the Tracking Performance. The position of the handler and the action of the dog are the keys to the judges' overall evaluation. If

the handler is on the track or at a turn and the dog is working but has not given a positive indication to the handler to move, the judges should wait for the handler to commit to a direction. On the other hand, if the handler has been led off the track by the dog, and the dog is casting widely trying to find a scent that is nonexistent in this area, the dog and handler may be called off the track. It is a good practice to let the dog and handler travel an adequate distance away from the track before failing the performance. However, if the dog has stopped working, the dog must be failed. Special care must be taken to prevent the dog from wandering into the proximity of another track in an adjacent field. The timing for calling the dog and handler off the track is all-important; there must be no question in either judge's mind. For this reason, it is recommended that the judges be in close proximity and communication with each other. This does not mean that there should be ongoing dialogue between the judges, only that consultation should be easy.

Section 14. Judges' Qualifications. Tracking judges must be familiar with the various conditions that exist when a dog is required to work a scent trail. Scent conditions, weather, terrain, ground cover, wind direction, and age of scent must be considered. A thorough knowledge of these factors is necessary. In addition, the TDX judge must be experienced in advance tracking and familiar with how types of obstacles and cross-tracks affect a dog's work.

A VST judge should be familiar with scenting conditions in an area consisting of more than just vegetation. Buildings, other structures, and a variety of surfaces can affect the scent.

TDX judges, Provisional TDX judges, and TD judges who have earned a VST title will be eligible to apply to judge VST. Prospective judges are required to attend an AKC Tracking Seminar, presented by AKC staff, within a 3-year period of applying and must apprentice judge under two (2) judges. The apprentice assignments must be at two (2) different tests and the judge may not be a member of the apprentice's household or immediate family.

Section 15. Sample Charts

TD Chart Information

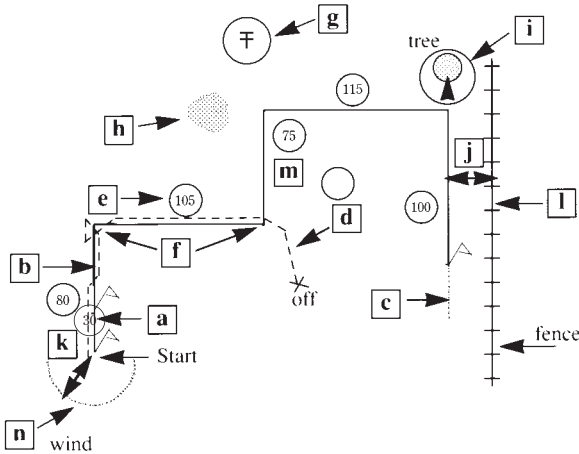

- 30 yards between the two starting flags.
- Must be at least 30 yards beyond the 2nd starting flag to the 1st turn.
- The tracklayer proceeds straight ahead for 30 yards, after dropping the article.
- Indicate dog's path with dashes (may use red).
- Circle distances between turns.
- Must have both right turns and left turns, at least two right angle turns well out in the open.
- Telephone pole used to indicate direction of leg.
- Rock used to indicate location of turn.
- Tree used to indicate direction of leg and location of turn.
- Track must be at least 15 yards from boundary or fence.
- Keep spectators 50 yards from the start.
- Indicate major features such as fences, roads, hills, slopes, vegetation, etc.
- Legs must be at least 50 yards long.
- Indicate direction of wind at start.

GENERAL COMMENTS FOR ALL CHARTS

- Angles on the chart should be approximately the same as the angles on the track.
The lengths of the legs should be approximately proportional to the legs of the track.
- Keep copies of charts and field notes for at least six months. Charts should have sufficient details so that with the help of field notes the track could be reconstructed.
- Use a pen to make the charts—make sure copies are clear.

One Way to Plot a TDX Start

- Judges determined an arc of 180 degrees. It should be possible for the track to go in any direction in this arc.
- Judges put in the starting flag.
- Judges set the path of handler and dog's approach perpendicular to the arc.
- Judges determine the direction of the track.
- Judges make sure the tracklayer approaches the starting flag straight along the direction of the track for at least 30 yards.

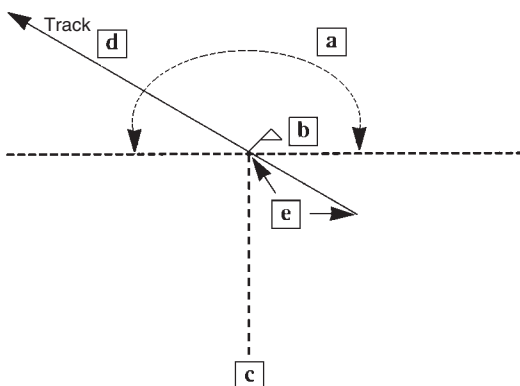

TDX Chart Information

- 30 yard straight in approach to start flag for tracklayer.
- 180 degree arc, if possible, for direction of the 1st leg.
- Handler and dog approach at less than 90 degrees to the direction of the tracklayer.
- Obstacle clearly identified and yards indicated.
- Crosstrack has direction and shall be at least 30 yards from obstacle, 50 yards from a turn and at least 75 yards from the Start, including the entrance and exit of the tracklayer.
- Each segment of the leg marked with yards.
- Total yards for each leg circled.
- Cross tracklayers proceed 50 yards in a straight line before the first crossing of the track, and more than 50 yards after 2nd crossing before exiting.
- Article shall be dropped at least 30 yards from a turn, obstacle or crosstrack.
- Drop in woods is at least 30 yards from turn and 30 yards from the exit of the woods that are the obstacle.
- Minimum length of any leg is 50 yards.
- Landmarks and turn markers are clearly indicated.
- Crosstracks are widely separated.
- Articles are widely separated.
- Tracks contain maximum of 7 turns.
- Tracks contain 3 obstacles if possible, with 2 being the minimum.
- Track meets the yardage requirement of 800 to 1000 (960).
- Wind direction at the start is indicated.
- Start and finish are clearly marked.
- Chart contains the Registration Number of the dog.

TDX Chart

DOG'S CATALOG # 1 TRACK# 1

Chart the track in solid line; the dog's course in broken line

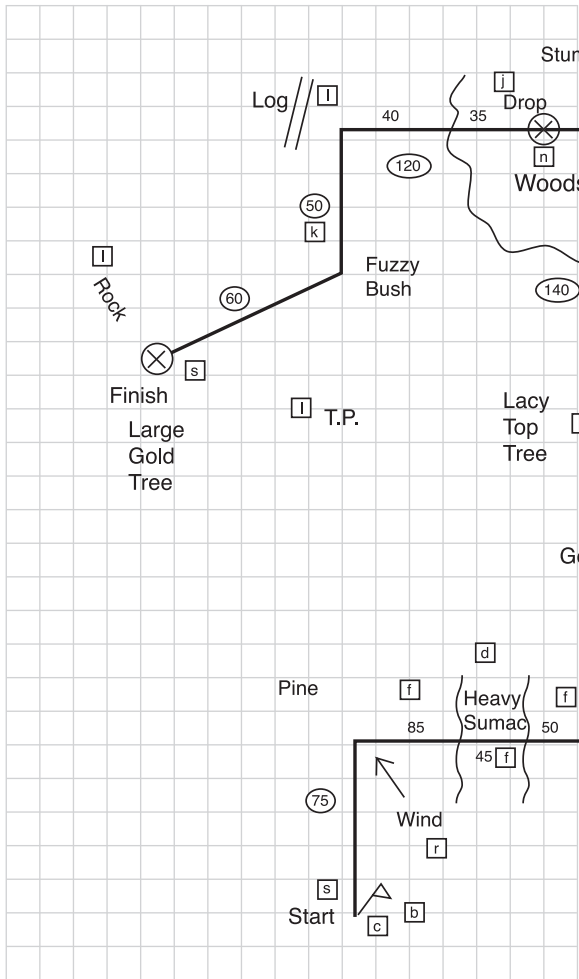

Passed or Failed Passed
 (if failed state reason) _____
 Tracklayer Started 7:00 A.M.
 X-Tracklayer Started 8:30 A.M.
 Dog's Starting Time 10:00 A.M.
 Dog's Finishing Time 10:25 A.M.
 Ground Conditions Medium Dry
 Weather Conditions Cool and Sunny
 Wind Speed Light

If dog is absent, mark

I hereby certify that I have judged the above dog after having read the best of my ability.

TOTAL YARDS 960
 line on graph below.

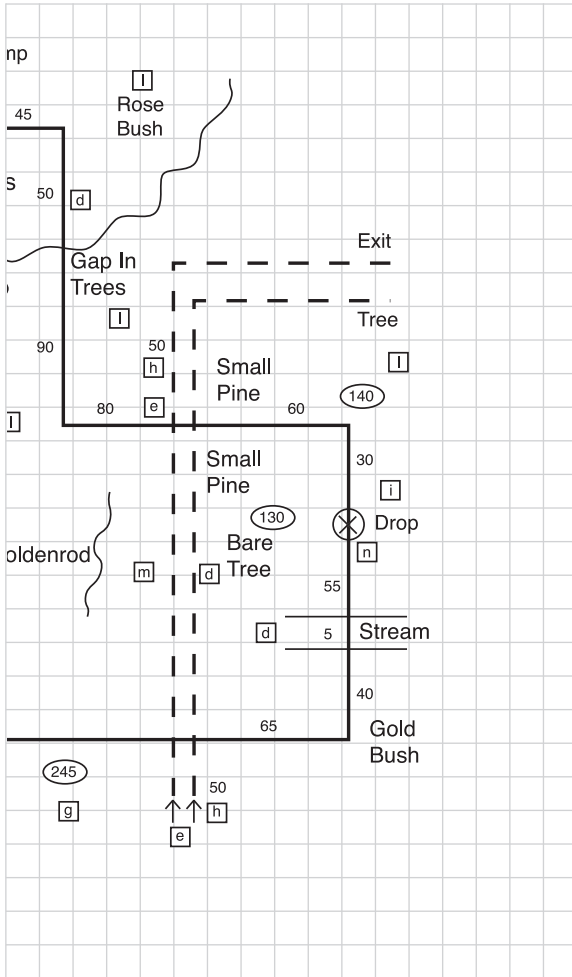

Articles: 1. Sock 2. Slipper
 3. Handkerchief 4. Glove
 Obstacles/ Surfaces: 1. Heavy Sumac 2. Stream
 3. Woods 4. _____
 Breed/Sex German Shepherd
 AKC Regis.# D00000000
 Event # 200000000

"absent" on the page.
 the instructions on the cover of this book and followed them out to

Joseph Tracker
 Judge's Signature

VST Chart Information

- a. 30 yards straight in approach to start flag for tracklayer.
- b. 180 degree arc, if possible, for direction of the 1st leg.
- c. Handler and dog approach at less than 90 degrees to the direction of the tracklayer.
- d. Start and first 20 yards is on grass.
- e. Each change of surface is clearly marked as to type of surface and yards for each change of surface.
- f. Total yards for each leg is circled.
- g. At least 3 different surfaces, including 1 vegetated and 2 non-vegetated were used.
- h. All major structures are clearly identified, i.e., buildings, roadways, parking lots and bridges.
- i. Drop is at least 20 yards from a turn.
- j. There is no drop on any short connecting leg.
- k. Minimum length of any leg is 30 yards.
- l. The non-fringeable, moment of truth, hard surface turn meets the requirements.
- m. Drop number 2 or 3 is on a non-vegetated surface.
- n. Landmarks and turn markers are clearly indicated.
- o. Articles are widely separated.
- p. Start article must be fabric or leather.
- q. Track contains at least 4 but not more than 8 turns.
- r. Track contains both right angle and left angle turns (90 degree turns).
- s. Track meets the yardage requirements of 600 – 800 (783).
- t. Track is comprised of 47.5% non-vegetated surfaces (track requires 33 1/3%-66 2/3%).
- u. Wind direction at the start is indicated.
- v. Start and finish are clearly marked.
- w. Chart contains the Registration Number of the dog.
- x. Chart has a legend.

NOTES

VST Chart

DOG'S CATALOG # 1 TRACK# 1

Chart the track in solid line; the dog's course in broken

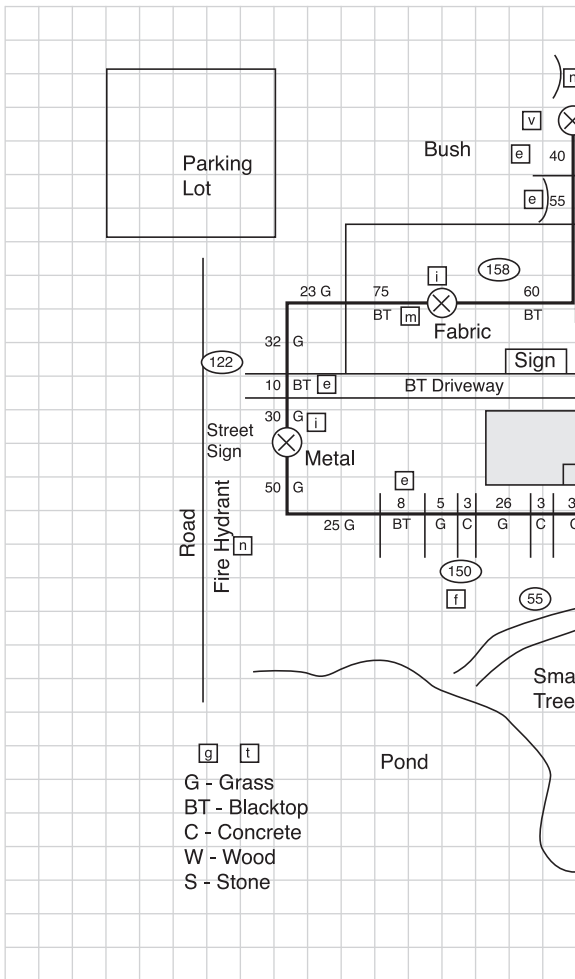

Passed or Failed Passed
 (if failed state reason)

Tracklayer Started 8:00 A.M.

X-Tracklayer Started _____

Dog's Starting Time 11:00 A.M.

Dog's Finishing Time 11:52 A.M.

Ground Conditions Variable-Office Complex

Weather Conditions Warm Cloudy

Wind Speed Moderate

If dog is absent, mark

I hereby certify that I have judged the above dog after having read the best of my ability.

TOTAL YARDS 783 VEG 411
 line on graph below. NON-VEG 372

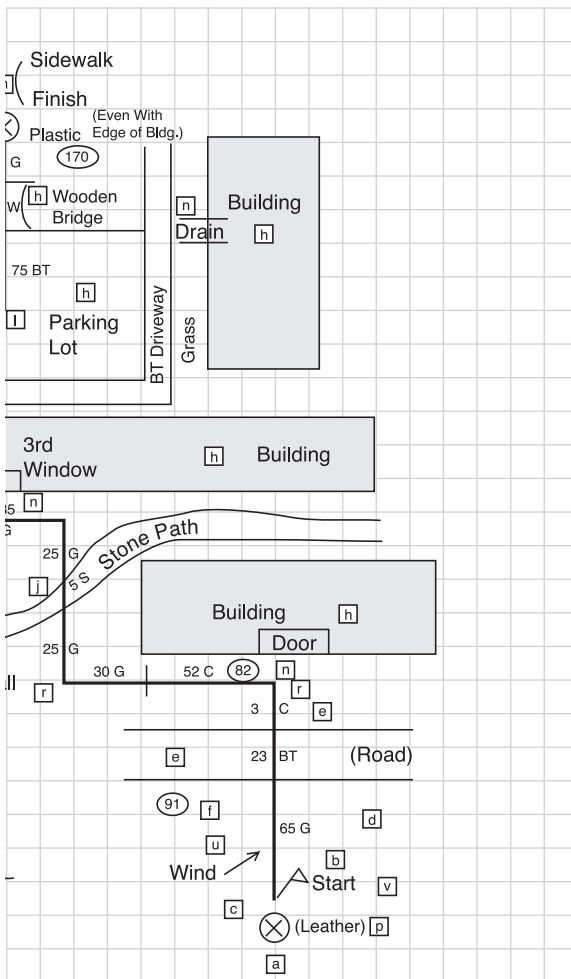

Articles: 1. Leather 2. Metal

3. Fabric 4. Plastic

Obstacles/
Surfaces: 1. Grass 2. Blacktop
 3. Wood 4. Concrete

Breed/Sex Golden Retriever - Bitch

AKC Regis.# SN00000000

Event # 2000000000

"absent" on the page.

the instructions on the cover of this book and followed them out to

Joseph Tracker

Judge's Signature

Sample TD / TDX / VST

DOG'S CATALOG # _____ TRACK# _____

Chart the track in solid line; the dog's course in broken

A large grid for charting track and dog's course. The grid is 20 columns wide and 30 rows high. The first two columns are intended for track information, and the remaining 18 columns are for the dog's course.

Passed or Failed _____

(if failed state reason) _____

Tracklayer Started _____

X-Tracklayer Started _____

Dog's Starting Time _____

Dog's Finishing Time _____

Ground Conditions _____

Weather Conditions _____

Wind Speed _____

If dog is absent, mark

I hereby certify that I have judged the above dog after having read the best of my ability.

TOTAL YARDS _____ VEG _____
line on graph below. NON-VEG _____

A large grid for graphing data, consisting of 20 columns and 30 rows of small squares.

Articles: 1. _____ 2. _____

3. _____ 4. _____

Obstacles/ 1. _____ 2. _____

Surfaces: 3. _____ 4. _____

Breed/Sex _____

AKC Regis.# _____

Event # _____

“absent” on the page.

the instructions on the cover of this book and followed them out to

Judge's Signature

Glossary of Terms

Moment-of-Truth – a non-fringeable, non-vegetated surface turn

Non-fringeable – a turn that is not influenced by vegetation

Rescent – Allowing the dog to take scent from the start article or other articles found on the track in such a way that it does not indicate the direction of the track or indicates a point on the ground where the dog should begin to search.

Restart – A behavior by the exhibitor that would indicate to the dog that he should begin searching a specific area or track in a given direction.

Untitled dog – a dog that has not titled in the test they are entering.

Index to Tracking Regulations	Chapter	Page
A		
Absent	Chap 2	9
Abuse	Chap 2	7
Accepting entries	Chap 1	4
Age of Track		
Tracking Dog	Chap 3	14
Tracking Dog Excellent	Chap 4	16
Variable Surface Tracking	Chap 5	19
Aiding dog	Chap 4	18
Alternate list	Chap 1	4
Alternate track	Chap 2	7
Articles		
Approving Articles		
Tracking Dog Test	Chap 2	8
Tracking Dog Excellent	Chap 3	15
Tracking Dog Excellent	Chap 4	17
Variable Surface Tracking	Chap 5	19
Placement		
VST	Chap 5	18, 19
Missing Article		
TD, TDX	Chap 2	12
VST	Chap 5	20
Assistance to handler	Chap 2	11
B		
Bitches in season	Chap 2	8
C		
Cell phone numbers	Chap 1	6
Certification	Chap 3	13
Chairperson judging or entering	Chap 1	1
Chief track-layer	Chap 1	2
Clothing, protective	Chap 2	13
Club responsibilities	Chap 1	6
(See also)	Guidelines	24
Commands and signals	Chap 2	10
Complexity	Chap 2	7
Compliance and regulations	Chap 1	3
Cross-tracks		
Cross-tracklayer present	Chap 2	9
Requirements	Chap 4	16
D		
Decisions	Chap 2	7
Declining entries	Chap 1	2
Disqualification	Chap 1	2
Disturbances	Chap 2	7
Distractions on the track	Chap 2	10
Dogs running free	Chap 1	6
Dogs that may not compete	Chap 1	3
Drawing		
Entries	Chap 1	4

Tracks	Chap 2	8
Track exchange policy	Chap 1	4, 5
Duration of test	Chap 1	4
E		
Eligibility		
General	Chap 1	3
Tracking Dog	Chap 3	13
Tracking Dog Excellent	Chap 4	15
Variable Surface Tracking	Chap 5	18
Entries		
Draw	Chap 1	4
Alternate list	Chap 1	4
(See also "Obedience Regs")	Chap 1	2
Errors in track laying	Chap 2	9
Event Committee		
Members and responsibilities	Chap 1	1
Excusals	Chap 2	7
Exhibiting limitations	Chap 1	3
F		
Food and motivational items	Chap 2	11
Fouling the track	Chap 2	11
Fouled track	Chap 2	7
Field chart instructions	Chap 2	11
G		
Glove or wallet	Chap 3	15
Guiding and restraining	Chap 2	11
H		
Harness requirements	Chap 2	10
Handler/start article	Chap 3	15
Handlers no assistance	Chap 2	11
Handlers, judge assisting	Chap 2	11
I		
Identification on field		
Handler	Chap 1	3
Dog	Chap 2	10
J		
Judges Books		
Blank chart	Page	36
Tracking Dog	Chap 2	11
Example chart	Page	28
Tracking Dog Excellent	Chap 4	18
Example chart	Page	30
Variable Surface Tracking	Chap 5	21
Example chart	Page	34
Judges		
Exhibiting	Chap 1	3
Provisional	Guidelines	23
(See also)	Chap 2	7
Soliciting	Guidelines	22

Judges (2) at tests	Chap 1	6
Judges present at drawing	Chap 2	8
Judges may not advise	Chap 2	13
Judging assignments	Chap 1	6
(See also)	Guidelines	22
Judges program	Chap 1	6
Judges position during test	Guidelines	26
Judges qualifications	Guidelines	27
L		
Leash	Chap 2	10
Length of tracks		
Tracking Dog	Chap 3	14
Tracking Dog Excellent	Chap 4	16
Variable Surface Tracking	Chap 5	18
M		
Matches	Chap 1	2
Match ribbons	Chap 1	4
N		
National Specialty Clubs	Chap 1	1
Number of tests per year	Chap 1	1
O		
Obstacles		
TD	Chap 3	14
TDX	Chap 4	17
Aiding the dog	Chap 4	18
VST	Chap 5	19
P		
Passing performance	Chap 2	12
Protective clothing for dogs	Chap 2	13
Plotting tracks		
General	Chap 2	7
People allowed in field	Chap 2	7
VST	Guidelines	25
R		
Random drawing	Chap 1	4
Rescheduled test	Chap 1	4
Restarts		
TD	Chap 3	15
TDX	Chap 4	17
VST	Chap 5	20
Re-testing	Chap 2	10
Ribbons and prizes	Chap 1	4
Risk	Chap 1	3
Rules Applying to Dog Shows	Chap 1	2
Restraining	Chap 2	11

S

Starts

TD	Chap 3	15
TDX	Chap 4	17
VST	Chap 5	20
Start article	Chap 2	8
(see also)	Chap 3	15
Specialty clubs	Chap 1	5
Site limitations	Chap 1	1
Secretaries judging or entering	Chap 1	2
Substitution of tracks	Chap 1	6
Superintendents can not show	Chap 1	3

T

Test chairperson	Chap 1	1
------------------	--------	---

Titles

TD	Chap 3	14
TDX	Chap 4	15
VST	Chap 5	18
CT	Chap 6	21
Titling track (alternate track)	Chap 2	7
Track visibility	Guidelines	23

Track Laying

General	Chap 2	9
Footwear	Chap 2	9
Errors	Chap 2	9

Track Requirements

TD	Chap 3	14
TDX	Chap 4	16
VST	Chap 5	18

Turns

TD	Chap 3	14
TDX	Chap 4	16
VST	Chap 5	19

V

Verbal commands	Chap 2	10
Veterinarian	Chap 1	1
VST test requirements	Chap 5	18

W

Walking the tracks (judges)	Chap 2	7
Water for dogs	Chap 2	11
Weather	Guidelines	23

AKC Code of Sportsmanship

PREFACE: The sport of purebred dog competitive events dates prior to 1884, the year of AKC's birth. Shared values of those involved in the sport include principles of sportsmanship. They are practiced in all sectors of our sport: conformation, performance and companion. Many believe that these principles of sportsmanship are the prime reason why our sport has thrived for over one hundred years. With the belief that it is useful to periodically articulate the fundamentals of our sport, this code is presented.

- Sportsmen respect the history, traditions and integrity of the sport of purebred dogs.
- Sportsmen commit themselves to values of fair play, honesty, courtesy, and vigorous competition, as well as winning and losing with grace.
- Sportsmen refuse to compromise their commitment and obligation to the sport of purebred dogs by injecting personal advantage or consideration into their decisions or behavior.
- The sportsman judge judges only on the merits of the dogs and considers no other factors.
- The sportsman judge or exhibitor accepts constructive criticism.
- The sportsman exhibitor declines to enter or exhibit under a judge where it might reasonably appear that the judge's placements could be based on something other than the merits of the dogs.
- The sportsman exhibitor refuses to compromise the impartiality of a judge.
- The sportsman respects the AKC bylaws, rules, regulations and policies governing the sport of purebred dogs.
- Sportsmen find that vigorous competition and civility are not inconsistent and are able to appreciate the merit of their competition and the effort of competitors.
- Sportsmen welcome, encourage and support newcomers to the sport.
- Sportsmen will deal fairly with all those who trade with them.
- Sportsmen are willing to share honest and open appraisals of both the strengths and weaknesses of their breeding stock.
- Sportsmen spurn any opportunity to take personal advantage of positions offered or bestowed upon them.
- Sportsmen always consider as paramount the welfare of their dog.
- Sportsmen refuse to embarrass the sport, the American Kennel Club, or themselves while taking part in the sport.



Complete text of booklet available at: www.akc.org

The American Kennel Club
8051 Arco Corporate Drive, Suite 100
Raleigh, NC 27617-3390
Tel: (919) 816-3575

E-mail: tracking@akc.org

© 2009 The American Kennel Club, Inc.