

Pin Retainers - Weld-on End Plates - Pin Tags

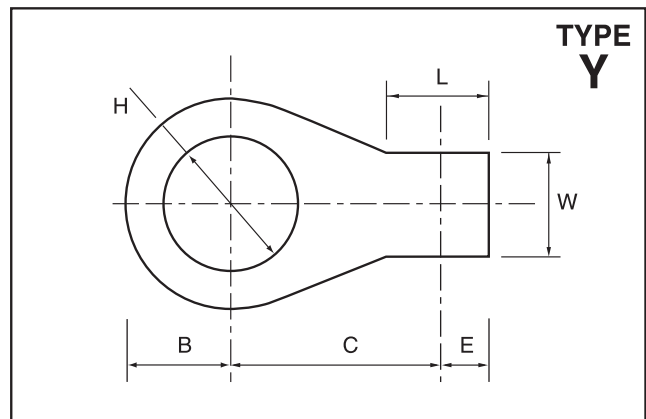
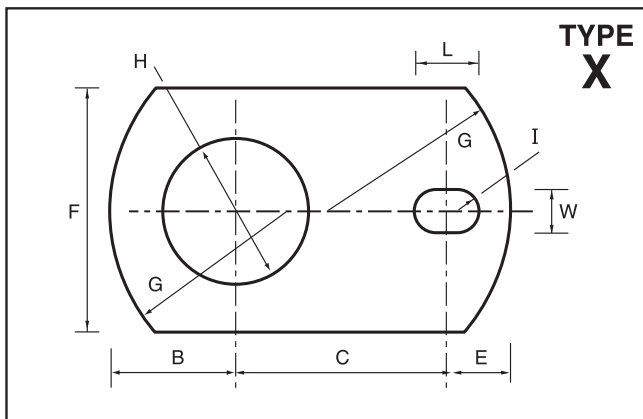
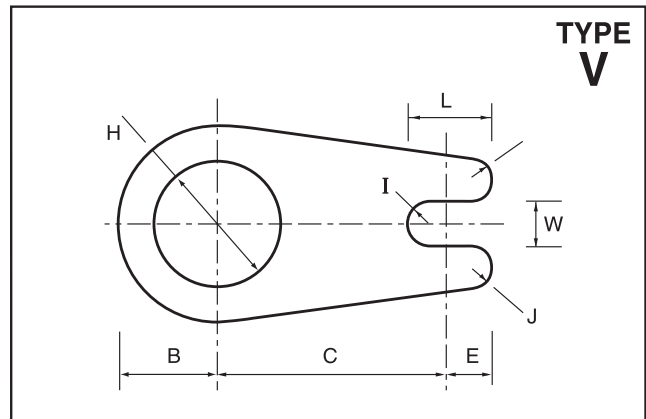
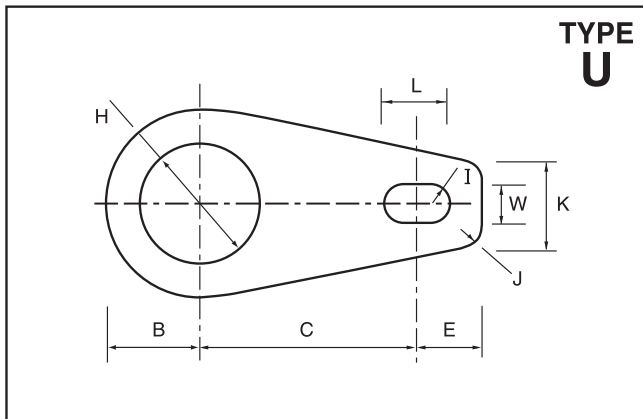
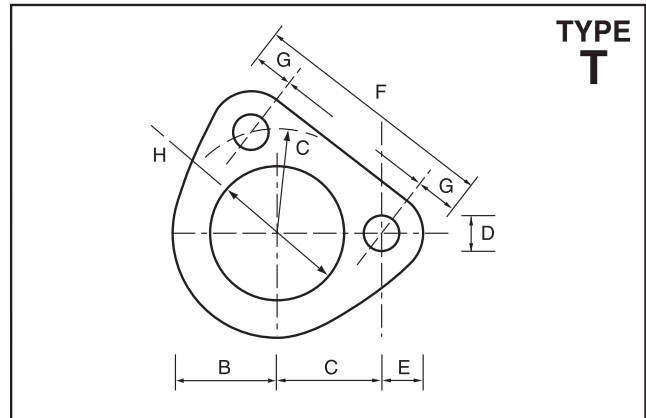
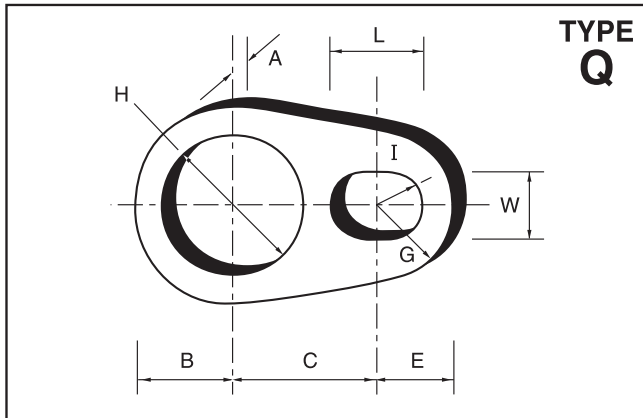
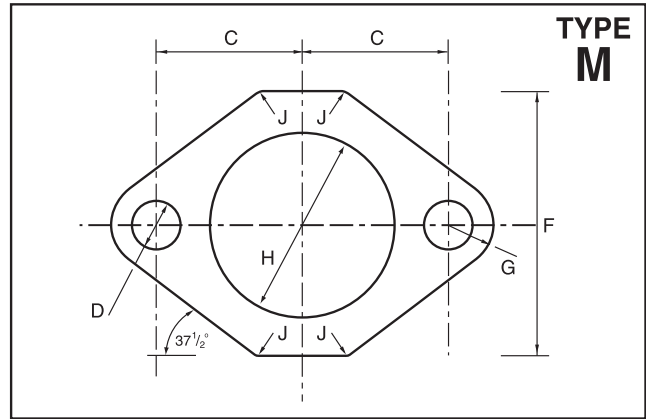
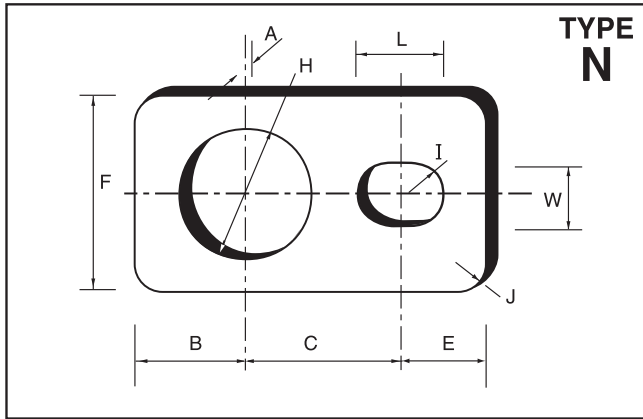

Pin Retainers - Weld-on End Plates - Pin Tags

PLATE TYPE SYMBOLS

- M = MANIFOLD FLANGE - TWO BOLT HOLES AT 80°
- N = RECTANGLE PLATE WITH BOLT HOLES
- Q = TEAR DROP SHAPE WITH BOLT HOLE
- R = ROUND FLANGE - NO BOLT HOLES
- T = TRIANGULAR FLANGE - TWO BOLT HOLES
- U = ROUND HEAD, TAPER SIDES, STRAIGHT END
- V = TEAR DROP SHAPE WITH OPEN END SLOT
- X = "RECTANGULAR" - STRAIGHT SIDES, CURVED ENDS PLUS BOLT HOLE
- Y = ROUND FLANGE WITH RECTANGULAR TAG
- Z = SQUARE PLATE - NO BOLT HOLES

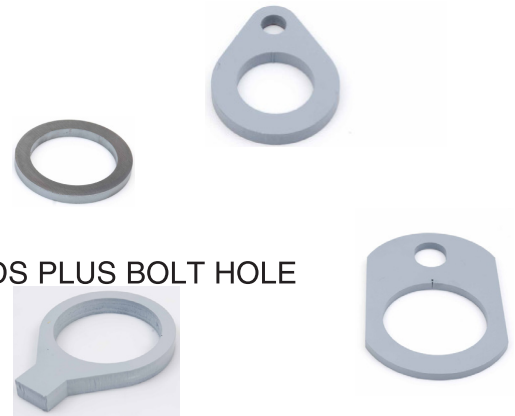

DIMENSION SYMBOLS - DIMENSIONS IN MILLIMETRES

- A = THICKNESS OF PLATE
- B = DISTANCE FROM CENTRE OF LARGE HOLE (PIN AXIS) TO NEAR END OF PLATE
- C = DISTANCE FROM PIN AXIS TO CENTRE OF BOLT HOLE
- D = DIAMETER OF BOLT HOLE - OR SLOT SHOWN AS Lmm x Wmm
- E = DISTANCE FROM CENTRE OF BOLT HOLE TO END OF PLATE
- F = WIDTH OF PLATE
- G = RADIUS AT SMALL END OF PLATE
- H = DIAMETER OF LARGE HOLE (WHERE PIN IS WELDED ON)
- I = RADIUS OF SLOT
- J = BLEND RADIUS
- K = WIDTH OF SMALL END OF TAPERED PLATES
- L = LENGTH OF SLOT OR RECTANGULAR TAG
- W = WIDTH OF SLOT OR RECTANGULAR TAG

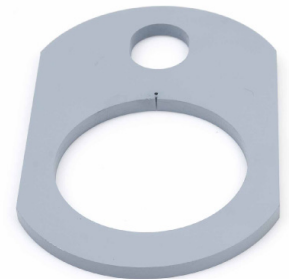

PART NUMBER SYSTEM FOR WELD-ON PLATES

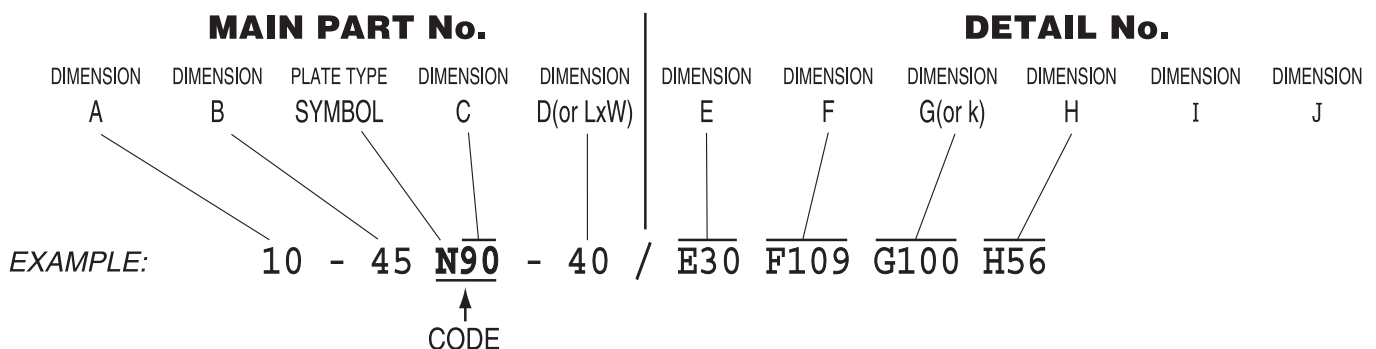

Pin Retainers - Weld-on End Plates - Pin Tags

Plate Thickness		CODE		Price Ex GST				Pin Hole Diameter	
6 mm	46	M35	11	\$10	E11	F65	G11	H48	J10
8 mm	35	Q34	12	\$12	E12	-	-	H29	
8 mm	30	Q35	12	\$12	E12	-	-	H36	
6 mm	49	M37.5		\$11	E11	F75	G11	H58	J10
6 mm	35	U40	0	\$14	E0	-	K70	H43	
6 mm	35	T39	13	\$9	E15	F90	G15	H48	
6 mm	20	Q40	16x13	\$14	E15	-	G15	H21	Popular
6 mm	40	T42.5	13	\$10	E15	F90	G15	H58	
6 mm	35	Q43	14	\$15	E18	-	-	H50	
6 mm	34	Q44	27x21	\$17	E26	-	G26	H30	
8 mm	24	V44		\$10	E8	-	-	H37	
6 mm	22.5	X45	14	\$10	E22.5	F45	-	H23	
8 mm	42	Q49	0	\$10	E15	-	G15	H50	
6 mm	33	Q50	27x23	\$19	E21	-	G21	H44	
16 mm	38	N51	33	\$24	E26	F76	-	H55	
8 mm	40	V52	25x16	\$10	-	-	-	H58	
8 mm	32.5	V57	25x20	\$18	E12.5	L25	W20	H44	J7
10 mm	28	X57	32x27	\$22	E25	F76	G50	H45	
6 mm	41	X58	35x30	\$26	E30	F75	G50	H46	129
12 mm	40	Y58	34x30	\$28	E17	-	-	H46	
6 mm	36	X59	36x30	\$26	E30	F75	G50	H45	
6 mm	40	X60	36x30	\$30	E30	F90	G60	H55	
6 mm	33	Q60	14	\$12	E15	-	-	H48	
6 mm	25	Q61	15x10	\$14	E14	L15	W10	H35	
8 mm	45	Y62	30x20	\$20	E15	L30	W20	H58	
16 mm	46	Y69	38x38	\$25	E19	L38	W38	H61	134
8 mm	44	Q70	21x13	\$16	E19	-	G19	H63	
8 mm	35	V71	32x27	\$20	E16	L32	W27	H48	
16 mm	46	Y71	38x38	\$23	E19	L38	W38	H66	136
12 mm	43	V77	44x25	\$30	E22	Volvo	L120F	H42	
12 mm	36	Y78	32x29	\$18	E16	-	-	H55	
16 mm	35	Q79	31 Dia	\$20	E25	-	G25	H37.5	
10 mm	53	Q80	38x32	\$30	E33	-	G30	H60.5	
10 mm	50	V80	40x25	\$40	E20	F100	-	H65	
8 mm	50	X80	48x40	\$40	E42	F100	G95	H63	
10 mm	53	Q81	38x32	\$30	E33	-	G30	H60.5	
10 mm	53	X81	42x32	\$34	E38	F100	G95	H66	
12 mm	55	V82	37x28	\$30	E18	Volvo	L120F	H70	
10 mm	50	X82	44x40	\$34	E40	F100	G95	H72	
16 mm	62	Y81	38x38	\$18	E19	L38	W38	H95	
12 mm	40	Y83	30x30	\$30	-	-	-	H40	
8 mm	35	V83	24x16	\$15	E12	J8	K48	H46	
20 mm	56	Y84	46x38	\$48	E23	L46	W38	H66	160
8 mm	56	Q85	21x13	\$18	E22	G22	-	H82	
12 mm	55	U85	50x40	\$30	E45	I=20	J20	H67	K80
20 mm	55	Y85	34x40	\$48	E17	L34	W40	H76	160
20 mm	66	Y86	26x40	\$34	E13	L26	W40	H86	163
20 mm	60	Y87	25x40	\$34	E13	L25	W40	H86	160
20 mm	65	Y88	25x40	\$34	E13	L25	W40	H96	166
8 mm	35	V88	32x27	\$20	E16	L32	W27	H48	

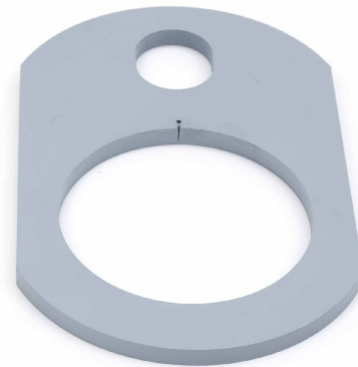

Minimum \$150
applies before GST & Freight

Tools and Accessories
may be used to make up
Minimum Wholesale Orders of \$150
All prices subject to change without notice

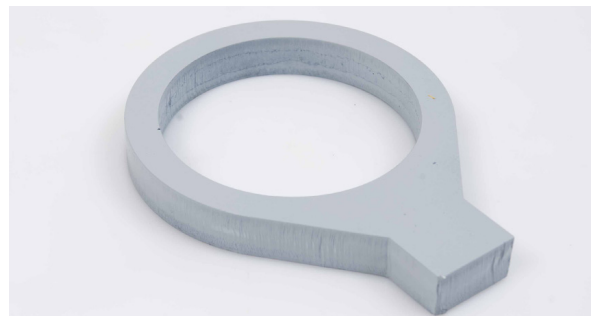

Pin Retainers - Weld-on End Plates - Pin Tags

Plate Thickness	CODE	Price Ex GST	Pin Hole Diameter
12 mm	44 V89	50x30 \$39	E25 L50 W30 H48 I=15,J8
12 mm	85 X89	48x40 \$24	F125 H80 200
20 mm	60 Y89	34x38 \$28	E17 L32 W38 H76
20 mm	60 Y90	50x40 \$50*	E25 L50 W40 H76 175
10 mm	35 Q90	22x16 \$22	E25 - G25 H46
12 mm	68 X90	48x40 \$34	E42 L48 W40 H81 200
10 mm	42 Q91	22x16 \$30	E24 - - H56 155
20 mm	60 Y91	40x40 \$50	E20 L40 W40 H86 170
12 mm	68 N91	48x40 \$20	E42 L48 W40 H91
12 mm	68 X91	48x40 \$34	E42 L48 W40 H91 200
12 mm	61 X92	44x40 \$34	E38 F125 G100 H91 190
12 mm	50 X95	40x30 \$30	E38 F100 G80 H70
20 mm	67 Y96	28x38 \$36	E14 L28 W38 H106 177
8 mm	41 Q97	13 \$22	E22 - G22 H46
16 mm	45 N100	16 \$26	E26 F90 J15 H49
8 mm	49 Q100	35x33 \$28	E25 - G25 H66
12 mm	65 Q101	48x40 \$34	E44 L48 M40 H75
20 mm	60 Y100	50x40 \$32	E25 L50 W40 H86 185
20 mm	70 Y101	52x52 \$32	E26 L52 W52 H110 196
12 mm	39 X102	44x30 \$30	E42 F80 G80 H55 183
18 mm	60 Y103	35x65 \$48	E18 - - H85 181
10 mm	38 X105	40x30 \$25	E42 F80 G80 H46 183
12 mm	95 Y105	80x100 \$30	E40 L80 W100 H136
10 mm	38 X107	40x30 \$30	E36 F80 G80 H55 183
16 mm	42 Y107	45x39 \$46	E22 L45 W39 H65 172
18 mm	80 Y108	24x38 \$38*	E12 L24 W38 H96 200
16 mm	50 N110	0 \$28	E20 F101 - H67
16 mm	47 Y111	40x40 \$30	E20 L40 W40 H76 176
12 mm	51 X114	52x40 \$30	E39 F102 G70 H70 204
12 mm	51 X115	40x30 \$30	E36 F100 G70 H85 200
12 mm	65 U117	66x32 \$40	E45 J25 K80 H 225
12 mm	70 X119	48x40 \$49	E36 F150 G100 H106 225
12 mm	75 Y119	60x80 \$54	- - - H116 225
12 mm	84 Q120	40x48 \$52	E38 F150 - H106 242
12 mm	70 X120	48x40 \$50	E35 F150 G100 H117 225
12 mm	97 X121	48x40 \$50	E38 F150 G100 H117 255
12 mm	85 Y122	75x100 \$50	E38 - - H136 245
20 mm	69 Y126	52x52 \$65	E26 L52 W52 H105
20 mm	68 Y127	60x60 \$65	E30 L58 W60 H106 225
20 mm	72 Y130	60x60 \$65	E30 L60 W60 H116 232
20 mm	75 Y133	35x54 \$65	E17 L35 W54 H94 225
12 mm	100 X130	55x45 \$60	E50 F180 G100 H136 280
16 mm	65 U144	0x0 \$40	E16 K32 H106 225
16 mm	65 Q148	46 \$46	E35 - - H76
16 mm	65 Q149	46 \$38	E35 C150 H86 250
16 mm	65 Q150	46 \$40	E35 - - H106 250



Bushes and Pins
Seals and Shims
Cutters and Tools
Retail Orders \$110 & under add 50%
 Plus freight & GST. All prices subject to change without notice

Indexation of Grease Exits to End Plates

Plate is viewed with pin hidden, as viewed on the machine, or as by a person welding the plate.
 The long end of the PLATE (or bolt hole end) at 12 o'clock, (or pointing away from person welding).
 The grease exit position on the circumference is described in an o'clock position, ie, for pin at right: 3 o'clock.
 Unless specified, assume grease exit is at 6 o'clock, abbrv: "clk".

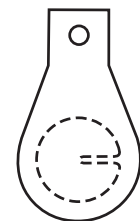

Newcastle - Sydney Region - Australia

Pin Retainers - Weld-on End Plates - Pin Tags

Plate Thickness	CODE	Price Ex GST	Pin Hole Diameter
12 mm	55 X150	52x40 \$52	E20 H
12 mm	46 X151	52x43 \$52	E51 F160 G125 H81
20 mm	85 Y150	40x50 \$65	E20 L40 W50 H102 254
20 mm	75 Y154	35x40 \$50	E17 L35 W40 H125 244
12 mm	120 X160	55x45 \$90	E55 F230 G120 H156 335
16 mm	60 Y163	62x50 \$55	E30 L60 W50 H71 253
20 mm	53 Y195	70x48 \$96	E35 L70 W48 H84 283x130
12 mm	68 V196	50x32 \$46	E35 L51 W32 H66
20 mm	69 Y199	60x50 \$60	E25 L60 W50 H76 298
20 mm	83 Y203	64x44 \$60	E32 L64 W44 H109 318
20 mm	75 Y205	50x50 \$60	E25 L50 W50 H96 305

Round End Plates

OD	ID	Width	Price Ex GST
35 Ø	x H23	x 6	\$10
50 Ø	x H28	x 6	\$10
58 Ø	x H33	x 6	\$10
	H34		
55 Ø	x H37	x 12	\$10
64 Ø	x H38	x 6	\$10
	H38.5		\$13
65 Ø	x H39	x 6	\$10
56 AF, 76 Ø	x H40	x 6	\$13
60 Ø	x H41	x 8	\$12
	H42		
	H43		
66 Ø	x H44	x 12	\$12
76 Ø	x H46	x 7	\$14
72 AF	x H48	x 6	\$10
72 AF	x H49	x 10	\$12
90 Ø	x H56	x 6	\$13
75 Ø	x H57	x 12	\$17
90 Ø	x H58	x 12	\$17
76 Ø	x H60	x 11	\$13
92 Ø	x H61	x 8	\$14
120 Ø	x H65	x 10	\$20
100 Ø	x H66	x 12	\$20
86 Ø	x H67	x 12	\$10
115 Ø	x H76	x 12	\$20
170 Ø	x H80	x 20	\$30
120 Ø	x H86	x 12	\$22
180 Ø	x H90	x 20	\$30
130 Ø	x H96	x 12	\$25
145 Ø	H106		
155 Ø	x H116	x 12	\$25

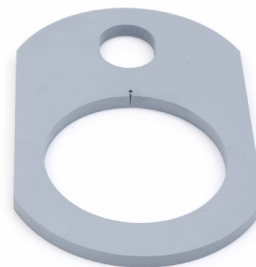

TYPE X



TYPE Q



TYPE Y

Indexation of Grease Exits to End Plates

Plate is viewed with pin hidden, as viewed on the machine, or as by a person welding the plate.
 The long end of the PLATE (or bolt hole end) at 12 o'clock, (or pointing away from person welding).
 The grease exit position on the circumference is described in an o'clock position, ie, for pin at right: 3 o'clock.



Newcastle - Sydney Region - Australia

Economy Shim Kits - Stainless Steel Shim Kits

PART No.	PRICE Ex GST		OUTSIDE	INSIDE	THICKNESS	NOTES
SM26	\$ 22		50 mm	26.0 mm	1mm, 2mm, 3mm	2 of each per Kit
SM31	\$ 22		55 mm	31.0 mm	1mm, 2mm, 3mm	2 of each per Kit
SSM31	\$ 25	Stainless	60 mm	31.0 mm	1mm, 2mm, 3mm	2 of each per Kit
SM33	\$ 22		63 mm	33.0 mm	1mm, 2mm, 3mm	2 of each per Kit
SSM33	\$ 25	Stainless	63 mm	33.0 mm	1mm, 2mm, 3mm	2 of each per Kit
SM36	\$ 22		70 mm	36.0 mm	1mm, 2mm, 3mm	2 of each per Kit
SSM36	\$ 26	Stainless	70 mm	36.0 mm	1mm, 2mm, 3mm	2 of each per Kit
SM37	\$ 20		63 mm	37.5 mm	3mm	10 per Pack
SM40.5	\$16/pr		80 mm	40.5 mm	6mm	2 per pack
SM41	\$ 24		74 mm	41.0 mm	1mm, 2mm, 3mm	2 of each per Kit
SSM41	\$ 27	Stainless	76 mm	41.0 mm	1mm, 2mm, 3mm	2 of each per Kit
SM44	\$ 20		70 mm	44.5 mm	3mm	10 per Pack
SM45	\$ 22		70 mm	45.2 mm	2mm	10 per Pack
SM46x30	\$110	Shim Kit 30	80 mm	46.0 mm	1mm, 2mm, 3mm	10 of each per Kit
SM46	\$ 27		80 mm	46.0 mm	1mm, 2mm, 3mm	2 of each per Kit
SSM46	\$ 30	Stainless	80 mm	46.0 mm	1mm, 2mm, 3mm	2 of each per Kit
SM51	\$ 30		96 mm	51.2 mm	1mm, 2mm, 3mm	2 of each per Kit
SSM51	\$ 36	Stainless	96 mm	51.2 mm	1mm, 2mm, 3mm	2 of each per Kit
SM52	\$ 36		127 mm	51.0 mm	1mm, 2mm, 3mm	2 of each per Kit
SSM56	\$ 39	Stainless	95 mm	56.0 mm	1mm, 2mm, 3mm	2 of each per Kit
SM61	\$ 32		100 mm	61.0 mm	1mm, 2mm, 3mm	2 of each per Kit
SSM61	\$ 39	Stainless	100 mm	61.0 mm	1mm, 2mm, 3mm	2 of each per Kit
SD64	\$ 38		101 mm	63.5 mm	10mm Single T79849	Thrust Washer
SD65	\$ 34		114 mm	65.0 mm	5mm Single T67205	Thrust Washer
SM66	\$ 34		115 mm	66.0 mm	1mm, 2mm, 3mm	2 of each per Kit
SSM66	\$ 39	Stainless	115 mm	66.0 mm	1mm, 2mm, 3mm	2 of each per Kit
SD66.3	\$ 32		127 mm	66.3 mm	5mm Single 9J2323	Steel Washer
SM71	\$ 36		120 mm	71.0 mm	1mm, 2mm, 3mm	2 of each per Kit
SSM71	\$ 40	Stainless	120 mm	71.0 mm	1mm, 2mm, 3mm	2 of each per Kit
SM77	\$ 39		127 mm	77.0 mm	1mm, 2mm, 3mm	2 of each per Kit
SM81	\$ 40		130 mm	81.0 mm	1mm, 2mm, 3mm	2 of each per Kit
SSM81	\$ 47	Stainless	130 mm	81.0 mm	1mm, 2mm, 3mm	2 of each per Kit
SD83	\$ 58	Bronze	152 mm	82.6 mm	5mm Single 7J3663	Bronze Washer
SM86	\$ 42		138 mm	86.0 mm	1mm, 2mm, 3mm	2 of each per Kit
SSM86	\$ 58	Stainless	138 mm	86.0 mm	1mm, 2mm, 3mm	2 of each per Kit
SM91	\$ 42		145 mm	91.0 mm	1mm, 2mm, 3mm	2 of each per Kit
SSM91	\$ 62	Stainless	145 mm	91.0 mm	1mm, 2mm, 3mm	2 of each per Kit
SM96	\$ 48		150 mm	96.0 mm	1mm, 2mm, 3mm	2 of each per Kit
SD101.5	\$ 130	Hardened	196 mm	101.57 mm	8mm Single 4J5690	Grooved, Ground
SD101.6	\$ 78	Bronze	173 mm	101.6 mm	6.35mm Single 4J5692	Bronze Washer
SP188-102-16	\$ 435	Phos Bronze	188 mm	102 mm	16mm Stepped Juganaut	0505 10027
SD101.6	\$ 128	Bronze	197 mm	101.65 mm	6.35mm Single 4J5691	Grooved Bronze
SD101.7	\$ 90	Hardened	196 mm	101.7 mm	8mm Single 4J5689	Precision Ground
SM102	\$ 50		155 mm	102.0 mm	1mm, 2mm, 3mm	2 of each per Kit
SSM102	\$ 66	Stainless	155 mm	102.0 mm	1mm, 2mm, 3mm	2 of each per Kit
SM111	\$ 56		165 mm	111.0 mm	1mm, 2mm, 3mm	2 of each per Kit
SSM111	\$ 68	Stainless	170 mm	111.0 mm	1mm, 2mm, 3mm	2 of each per Kit
SM121	\$ 60		185 mm	121.0 mm	1mm, 2mm, 3mm	2 of each per Kit
SM126	\$ 80		192 mm	126.0 mm	1mm, 2mm, 3mm	2 of each per Kit
SM131	\$ 86		210 mm	131.0 mm	1mm, 2mm, 3mm	2 of each per Kit
SSM131	\$ 96	Stainless	210 mm	131.0 mm	1mm, 2mm, 3mm	2 of each per Kit
SM141	\$ 94		220 mm	141.0 mm	1mm, 2mm, 3mm	2 of each per Kit
SM151	\$100		240 mm	151.0 mm	1mm, 2mm, 3mm	2 of each per Kit
SM161	\$118		250 mm	161.0 mm	1mm, 2mm, 3mm	2 of each per Kit
SM167	\$148		300 mm	167.0 mm	1mm, 2mm, 3mm	2 of each per Kit

Australian Made Shims

Bucket, Arm and Cylinder Joints
of excavators and wheel loaders
Heavy Load Joints. Boom Foot
Komatsu excavator shim
Caterpillar wheel loader shims
Kobelco excavator shims



Engineered Shim Applications

Moving joints earthmoving equipment
Australian Shim manufacturer
Boom Cylinder Ram Eye
Excavator Pivot Points
WA Loader Shims
Hitachi excavator shim
Earthmoving Shims Mackay
Perth Machinery Shims
Tree Harvester Attachment
Log Grapple Shim
Australia Grabs and Grapples
Rotator Pins and Bushes and Shims
Forestry Attachment Shim
NZ Industrial Shim
NZ Forestry Attachment Shim
Bucket Pin Shim
Forest Harvesting Attachment
Tasmania Industrial Supplies
Port Hedland Bearing & Shim
Australian made shims
All Shims Earthmoving overnight Australia
Brisbane Buckets Shims
Gambier Shims Next day delivery
Darwin Bushes & Shim
Mount Isa Shim supplies
Adelaide Industrial Shim & Bearing
Excavator Shims Melbourne Overnight
Komatsu Loader Shims WA
Airbag Shim deliveries Australia -wide

Bushes and Pins Seals and Shims Cutters and Tools

**Retail Orders \$110
& under add 50%**

Plus freight & GST. All prices
subject to change without notice