



extending impact

FACTORS INFLUENCING HOUSEHOLDS TO ADOPT
HAZARD-RESISTANT CONSTRUCTION PRACTICES
IN POST-DISASTER SETTINGS



 **OCRS**
CATHOLIC RELIEF SERVICES



extending impact

FACTORS INFLUENCING HOUSEHOLDS TO ADOPT
HAZARD-RESISTANT CONSTRUCTION PRACTICES
IN POST-DISASTER SETTINGS

A study by Catholic Relief Services

MARILISE TURNBULL
CHARLOTTE L. STERRETT
SEKI HIRANO
AMY HILLEBOE



COVER PHOTO

Catholic Relief Services partners with Caritas Bangladesh to provide comprehensive disaster risk reduction interventions in southern Bangladesh, an area highly prone to flooding and damage from cyclones. Here Rahima Begum discusses her future “dream home” with a community outreach worker from a hand-drawn teaching aid. She is slowly building a new home, saving money for materials through income-generating activities taught by Caritas Bangladesh. Rahima has benefitted from trainings in how to reinforce the house to better withstand cyclones. Photo by Jennifer Hardy for CRS

ACKNOWLEDGEMENTS

The project team expresses its gratitude to Catholic Relief Services’ staff and partners for their efforts in planning the country program visits and wide participation in the process. Without their unstinting support and engagement, this study would not have been possible.

We thank:

Santone Agesilas, Iftekhar Ahmed, Niaz Ahmed, Amjad Ali, Zahoor Ali, Sadiq Ali Shah, Daniel Andriatsimba, Jel Mar B. Bagacay, Susan Connolly, Sohel Costa, Joe Curry, Tasleem Dayo, Ferdinand Deriquito, Laura Dills, Rosendo Esteves Jr., Joanna Heil, Rubina Jan, Pradeep Kumar, Saima Mamon, Tara McCaw, Jel Mae C. Melliza, Kathleen Merkel, Kirtimayi Mishra, Krishna Mohan, Ranjan Mohanty, Katie Morris, Khair Muhammad, Paul Dennis Parian, Nida Parveen, Sailendra Pattanaik, Courtney Plummer, Jennifer Poidatz, Didier Rabenandrasana, Rémi Rakotobe, Roland Ramanampihery, Jean Paul Randrianantenaina, Harun Rashid, Norohasina Ratsimbazafy, Sumon Saha, Carlos Sanchez, Andrew Schaefer, Sanam Shaikh, Rekha Shetty, John Shumlansky, Hubert Sony, Lupe Staigers, Elizabeth Tromans, Maria Josephine (Pippin) Wijastuti

PROJECT TEAM

Study lead and author

Marilise Turnbull

Study lead and author

Charlotte L. Sterrett

Project manager and contributing author

Amy Hilleboe

Contributing author

Seki Hirano

Contributors

Vera Kreuwels, Jamie Richardson, Silla Chow, Susan van Duijl, Joanna Olsen

Technical and production editor

Solveig Bang

Technical illustrator

Waad Tammaa

Graphic artist

Chris Roy Taylor

Catholic Relief Services is the official international humanitarian agency of the United States Catholic community. CRS’ relief and development work is accomplished through programs of emergency response, HIV, health, agriculture, education, microfinance and peacebuilding. CRS eases suffering and provides assistance to people in need in 93 countries, without regard to race, religion or nationality.

Catholic Relief Services

228 West Lexington Street
Baltimore, Maryland 21201-3443
1.888.277.7575

www.crs.org

Suggested citation: Turnbull, M., Sterrett, C.L., Hirano, S. and Hilleboe, A. (2015). *Extending impact: Factors influencing households to adopt hazard-resistant construction practices in post-disaster settings. A study by Catholic Relief Services*. Baltimore, MD: Catholic Relief Services - United States Conference of Catholic Bishops.

© 2015 Catholic Relief Services. All rights reserved. This material may not be reproduced, displayed, modified or distributed without the express prior written permission of the copyright holder. For permission, contact pqpublications@crs.org.

Contents

Key terms & abbreviations	vi
Foreword	vii
Executive summary	viii
Introduction	xii
How the study was conducted	1
Study framework	1
Data collection	1
The 12 determinants of behavior	2
Participants	3
Analysis process	3
Program information	5
Program areas	6
Bangladesh	6
India	7
Madagascar	8
Pakistan	9
Philippines	10
Structural components of hazard-resistant construction	11
Hazard-resistant construction practices recommended by CRS	12
Results	14
Cues for action	15
Access	19
Perceived risk	24
Perceived positive consequences	26
Perceived self-efficacy	29
Perceived negative consequences	32
Perceived severity	35
Perceived action efficacy	38
Culture	41
Perceived social norms	44
Perceived divine will	47
Policy	49
Universal motivators	52
Conclusion and recommendations	55

Key terms & abbreviations

- **Users:** Non-beneficiaries who rebuilt their homes using one or more of the hazard-resistant construction practices applied and recommended by CRS.
- **Non-users:** Non-beneficiaries who did not use the hazard-resistant practices applied and recommended by CRS to rebuild their homes.

- **Barrier:** An obstacle that prevents people from using the hazard-resistant practices.
- **Behavior:** The action(s) of users and non-users with respect to the practices they choose for reconstructing their homes.
- **Enabler:** A factor that enables or encourages people to use the hazard-resistant practices.
- **Determinant:** What prompts, guides or drives people to do something differently/change their behavior.
- **Hazard-resistant construction practices recommended by CRS:** The combination of materials and construction practices designed to withstand hazards (such as floods, cyclones etc.) that CRS applied in its reconstruction programs and promoted to the wider community.
- **Home:** The house in which study participants live.
- **Resilience:** The capacity of people and communities to advance integral human development¹ in the face of shocks, cycles and trends. (CRS definition)

BCT	Behavior Change Theory
BSSS	Balasore Social Service Society
CFW	Cash for work
CRS	Catholic Relief services
CRED	Centre for Research on the Epidemiology of Disasters
DBC	Designing for Behavior Change [methodology]
DRR	Disaster risk reduction
GI	Galvanized iron
IEC	Information, education and communication
IHD	Integral human development
NGO	Nongovernmental organization
USD	United States dollar
VDMC	Village disaster management committee
VHT	Village help team
WASH	Water, sanitation and hygiene

1. Integral Human Development (IHD) is a central component of the CRS agency strategy and the work CRS does with its partners. The concept, founded in Catholic social teaching, affirms that human development cannot be reduced or separated into component parts. Rather, personal well-being can only be achieved in the context of just and peaceful relationships and a thriving environment. It is the sustained growth that everyone has the right to enjoy. IHD promotes the good of every person and the whole person; it is cultural, economic, political, social and spiritual.

Foreword

In a world at greater risk of climate change, where increasingly frequent and more intense disasters are becoming ‘the new normal’, Catholic Relief Services undertook this study to find new ways to advance community resilience to disasters beyond the common boundaries of emergency response, recovery and reconstruction programs. It is hoped that the insights presented in this report—what prompts people to adopt practices to increase their resilience, unaided by program support—will encourage humanitarian and development organizations to explore innovative ways to promote the adoption of disaster risk reduction practices and foster resilience in all communities at risk from disasters.

One of the greatest challenges of post-disaster housing reconstruction is the sheer scale of destruction and the resources required for recovery efforts. In the past decade, over 25 million people have been made homeless by disasters², but only a fraction of them became beneficiaries of reconstruction programs. Although beneficiary selection criteria must be established to fit the funding parameters of any program, there are typically many with limited capacities who also need assistance to reconstruct their homes, but who do not receive it.

Over the past decade, CRS has supported 165,000³ vulnerable families in disaster-affected communities to reconstruct their homes using specific construction practices that can better withstand cyclones, earthquakes, floods and other hazards. CRS field staff of those reconstruction programs observed that, in the same disaster-affected locations, women and men who were *not* beneficiaries of CRS programs were copying some of the CRS-promoted hazard-resistant construction practices as they rebuilt their homes using their own resources. As a result, CRS embarked on this multi-country study to better understand the motivations, barriers and enabling factors that contribute to people’s decisions to use hazard-resistant practices when they reconstruct after a disaster. The findings could be among the keys to designing community-led programs that foster resilience on a much greater scale than can be generated by any single project.

Jennifer Poidatz

Global Director of Humanitarian Response
Catholic Relief Services

.....
CRS undertook this study to find new ways to advance community resilience to disasters beyond the common boundaries of emergency response, recovery and reconstruction programs
.....

2. EMDAT, The International Disaster Data Base, Centre for Research on the Epidemiology of Disasters <http://www.emdat.be>
3. Between 2004 and 2013, 117,896 transitional and 47,272 permanent shelter solutions were provided through CRS programs.

Executive summary

More than 165,000⁴ vulnerable families in disaster-affected communities have been supported by Catholic Relief Services over the past decade to reconstruct their homes using specific construction practices that can better withstand cyclones, earthquakes, floods and other hazards. In the same disaster-affected communities, many other families who were *not* beneficiaries of CRS projects also rebuilt their homes using their own resources, often replicating some of the hazard-resistant construction practices recommended by CRS and its partners.

To understand what enables some people to act independently to reduce disaster risk through the construction of their homes, and what prevents others from doing so, CRS conducted a multi-country study using a recognized behavior change methodology. Designing for Behavior Change⁵ is a methodology used to understand what influences people's behavior by analyzing 12 determinants: what prompts, guides or drives people to behave in a certain way. In this study, each of the determinants analyzed relates to the use of hazard-resistant construction practices:

- **Perceived positive consequences:** The **advantages** people think using hazard-resistant construction practices will bring.
- **Perceived negative consequences:** The **disadvantages** people think using hazard-resistant construction practices will bring.
- **Perceived social norms:** Whether people think they will get **approval** or **disapproval** from family, friends, neighbors and others around them for using hazard-resistant construction practices.
- **Cues for action:** The things that **help remind people to do something** towards hazard-resistant construction or how to do it.
- **Perceived self-efficacy:** Whether people think they have the **knowledge and skills** to successfully carry out hazard-resistant construction practices.
- **Access:** Whether people have access to the **resources** (time, money, tools etc.) they need to use hazard-resistant construction practices.
- **Perceived risk:** Whether people think they are **at risk** if they do not use hazard-resistant construction practices.
- **Perceived severity:** How **serious** people perceive the consequences of a hazard event to be.
- **Perceived action efficacy:** Whether people think hazard-resistant construction practices are **effective**.
- **Perceived divine will:** Whether people believe their lives are influenced by **supernatural forces or religion**.
- **Policy:** Whether **laws or regulations (including informal ones)** influence the ways in which people construct their homes.
- **Culture:** Whether people think culture (**history, customs, lifestyle, values, practices**) within a self-defined group influences the ways in which people construct their homes.
- **Universal motivators:** While not considered determinants, universal motivators are **factors that motivate most people**, irrespective of other variables. Factors include: love, security, comfort, recognition, success, freedom, positive self-image, peace of mind, status, pleasure, and power.

4. Between 2004 and 2013, 117,896 transitional and 47,272 permanent shelter solutions were provided through CRS programs.

5. Designing for Behavior Change is based on the Health Belief Model, a widely accepted cognitive model which posits that a person's behavior is determined by his/her perceptions of threats to his/her well-being and of the effectiveness and outcomes of that behavior. Food Security and Nutrition Network Social and Behavioral Change Task Force (2013) *Designing for Behavior Change For Agriculture, Natural Resource Management, Health and Nutrition*. Washington, DC: Technical and Operational Performance Support Program.



Photo by Jemiller Hardy for CRS

Designing for Behavior Change is a methodology used to understand what influences people's behavior by analyzing 12 determinants: what prompts, guides or drives people to behave in a certain way.

The study found that five determinants of behavior significantly influenced the adoption of the hazard-resistant construction practices recommended by CRS and its partners by disaster-affected households that were not beneficiaries of their reconstruction programs.

Cues for action proved the most significant among these as a determinant of disaster-affected households' behavior. Demonstration homes constructed to show the use of the hazard-resistant practices were more effective than any other deliberate actions undertaken by CRS in influencing non-beneficiaries' choices during reconstruction. Observing at close hand the construction of CRS beneficiaries' homes also prompted many non-beneficiaries to adopt the practices. **Based on this knowledge, organizations such as CRS should maximize the 'cue' value of demonstration homes and beneficiaries' homes by increasing direct contact with them and the skilled laborers working in them. Instead of seeing homes only as program outputs, organizations should use them as multipliers / leverage points for extending impact beyond direct program beneficiaries.**

Access to the materials and skilled labor required to construct a home using hazard-resistant construction practices was also shown to be a significant determinant of disaster-affected households' behavior. A lack of resources was a barrier for many families, particularly for single-headed households and those with subsistence livelihoods. **To overcome this, organizations such as CRS should ensure that the hazard-resistant practices they promote are easier to access, both financially (access to money via savings, cash-for-work, livelihoods or other means) and physically (access to materials and skilled labor). This requires a substantial departure from the concept of providing a small proportion of disaster-affected families with new homes while others, who may be similarly poor and vulnerable, do not receive any support to help them 'build back safer'.**

Perceived risk also proved to be a significant determinant of disaster-affected households' behavior. When people felt that their community would be affected by another cyclone or flood in the near future and recognized that the way their home was constructed made them more vulnerable, they took action to construct a safer home. Just recognizing that another hazard was likely to occur was not enough to prompt people to change their construction practices. **To foster an accurate perception of risk at the household level, organizations such as CRS need to ensure that people understand the components of risk, and that the type of construction practices they choose directly affect whether or not their home will withstand a hazard event. This requires a greater investment in information and education than is normally made in reconstruction programs, as well as including the promotion of safe housing (along with resilient livelihoods and community organization) in long-term disaster risk reduction programs.**

Perceived positive consequences was also shown to be a significant determinant of disaster-affected households' behavior. People who



Photo by CRS staff

Demonstration homes constructed to show the use of the hazard-resistant practices were more effective than any other deliberate actions undertaken by CRS in influencing non-beneficiaries' choices during reconstruction.

directly associated the construction practices with preventing damage to their home during hazard events and increasing their home's overall stability and durability were more likely to adopt them than those who were unaware or unconvinced of such benefits. **To scale up the adoption of hazard-resistant construction practices, organizations such as CRS should ensure that people understand their advantages in severe climatic conditions and the everyday and long-term benefits of using them. This requires investing more time in understanding which aspects of their home are most important to each target group and creating a communications strategy that relates the recommended practices to them.**

Perceived self-efficacy was shown to be a moderately significant determinant of disaster-affected households' behavior, although its direct relationship with access and interlinkages with other determinants makes it difficult to ascertain its relative importance. People were prevented from using the practices when they felt they lacked the necessary skills and knowledge and were unable to pay a carpenter or mason to use them. **To overcome this complex barrier, organizations such as CRS should make program design choices based on knowledge of the relevant skill sets of the target communities, the extent to which skills need to increase for people to feel confident carrying out the practices, and the capacity of different sectors of the target communities to pay for skilled labor.**

The determinants that were shown to be less significant in this study were *perceived severity*, *perceived divine will*, *perceived negative consequences*, *perceived action efficacy*, *culture*, *perceived social norms* and *policy*. This does not mean, however, that programs to promote hazard-resistant housing should disregard these determinants. **Instead, organizations such as CRS should ensure that their assessment processes and monitoring systems enable them to make decisions based on knowledge of all common determinants of behavior, not assumptions about them.**

For example:

- *Perceived negative consequences* could result from an inadequate consultation process with beneficiaries prior to selecting the construction practices to be promoted in a reconstruction program.
- *Perceived severity* of the consequences of losing their home could vary among people with different forms of income generation, and *perceived action efficacy* could vary in areas of high immigration where some people may have had greater exposure to the use of hazard-resistant construction practices than others.
- *Perceived culture* and *perceived social norms* played little part in people's choices of construction practices in most of the locations of this study perhaps due to the high level of local knowledge held by CRS and partner staff whereby cultural and social norms were considered in the design of the project, but this may be more challenging for organizations operating

.....
Organizations such as CRS should ensure that their assessment processes and monitoring systems enable them to make decisions based on knowledge of all common determinants of behavior, not assumptions about them.
.....

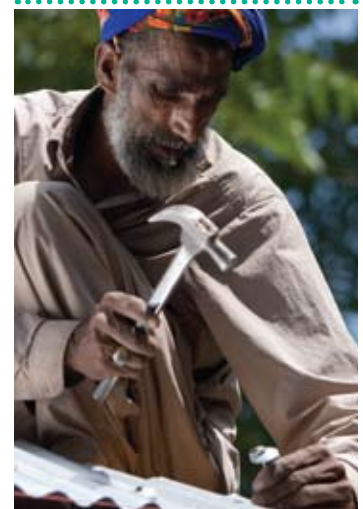

Photo by Jim Stipe for CRS

in areas of which they have limited prior knowledge or places where there is limited access.

- *Perceived divine will* affected people's behavior in one study location, underscoring the need for initial assessments to include an analysis of beliefs.
- *Policy* was also perceived to be of little or no significance with regard to the adoption of the hazard-resistant practices, mainly due to a lack of knowledge and weak implementation of national construction codes. **However, to promote sustainable and long-term disaster risk reduction, organizations such as CRS should contribute to efforts to make people living in at-risk areas aware of the relevant aspects of hazard-resistant construction codes and policies, and to support efforts to implement them.**

The study confirmed that *universal motivators* were, indeed, universal. People were motivated by having enough food, creating a better future for their children, and living in a safe home, albeit with different levels of priority in each location. **Organizations such as CRS should identify what people in their program areas want most in life, and use this knowledge to create incentives for using hazard-resistant construction practices toward peoples' goals.** Disaster risk reduction efforts could gain greater traction when associated with individual or family goals. For example, where most people are highly motivated to provide education for their children, organizations could develop communications strategies that explicitly relate the capacity to pay for education with the reduced costs of reconstructing through the use of hazard-resistant practices that prevent damage to and loss of family homes.

The study also highlighted the need for post-disaster housing reconstruction programs to correspond with affected peoples' own timeframes for reconstruction, which often begin immediately after a disaster. **To better synchronize external inputs with local dynamics, organizations such as CRS need to substantially increase investment in disaster preparedness, so that locally relevant designs incorporating the practices, as well as materials, technical support and communications plans, can be mobilized at short notice.**

Overall, this study shows the need for a transformation in the way reconstruction programs are conceived and implemented if organizations such as CRS want to substantially increase their impact. Technical shelter experts need to collaborate with experts in social research methods, communications, food security and livelihoods, to ensure that programs take into account multiple and inter-related determinants of people's behavior, to design programs to encourage the adoption of improved practices. The study also draws attention to the need and opportunities to promote hazard-resistant construction through longer-term disaster risk reduction programs, rather than waiting until a disaster occurs to reconstruct homes.

.....
The study shows the need for a transformation in the way reconstruction programs are conceived and implemented if organizations such as CRS want to substantially increase their impact.
.....



Photo by Jim Stipe for CRS



Children in Brickaville, Madagascar, where the community suffered damage to homes after Cyclone Giovanna. Photo by Susan Walters for CRS

Introduction

With the increase in the magnitude and frequency of disasters, coupled with diminishing funding available for post-disaster reconstruction, it is very rare that 100 percent of disaster-affected households will be offered housing reconstruction assistance. Humanitarian and development organizations must use targeting methods to make efficient use of the resources they have, channeling support to the most vulnerable, hoping that those with some resources will be able to recover and reconstruct with their own means. Unfortunately, many of those who do not benefit from disaster recovery assistance often build back in ways that render them more vulnerable to future disasters. Others, however, are motivated and able to “build back safer”. Before this study, CRS had limited knowledge of what differentiated these two groups.

CRS used the Designing for Behavior Change methodology to conduct a study on people’s perceptions of using CRS-recommended hazard-resistant construction practices in communities in five countries where CRS had implemented post-disaster reconstruction projects in the last six years: Bangladesh, India, Pakistan, the Philippines and Madagascar.

The findings of this study present an uncommon perspective on what determines the choices people make during reconstruction and how more people might be encouraged to adopt hazard-resistant construction practices of their own accord. By sharing these findings and related recommendations, CRS aims to deepen understanding of what constrains, motivates and enables people to make such choices, and to inspire organizations working with communities at risk of disasters to explore new ways to approach resilience-building.

.....

CRS aims to deepen its understanding of what motivates and enables people to adopt hazard-resistant construction practices of their own accord, or constrains them from doing so, and to inspire organizations working with communities at risk of disasters to explore new ways to approach resilience-building.

.....

How the study was conducted

STUDY FRAMEWORK

The Designing for Behavior Change methodology was chosen for this study, given that its objective was to understand why people acted or behaved in different ways with regard to the use of hazard-resistant construction practices. This methodology draws on models of behavior change that were originally developed in the health sector to understand, and influence, people's behavior in relation to health risks. More recently it has been used in other sectors such as water, sanitation and hygiene (WASH), and agriculture. It offers an innovative approach to understanding behaviors in relation to disaster risk reduction and housing reconstruction.

.....
Designing for Behavior Change methodology offers an innovative approach to understanding behaviors in relation to disaster risk reduction and housing reconstruction.
.....

DATA COLLECTION

Within this methodology, the key tool for understanding the factors that influence the behavior of a specific population group is a Barrier Analysis survey structured around a set of 12 determinants that commonly affect or determine people's actions, either by creating a barrier to taking action, or by driving, prompting or enabling it. In this study, the determinants are related to the use of the hazard-resistant construction practices recommended in a CRS program, as explained in Box 1.

To triangulate and explain the findings, CRS added questions on household income sources, land tenure and house ownership, gender, assistance provided by other organizations, and knowledge of a CRS program.

A complementary questionnaire was also produced for interviewing skilled laborers (carpenters, masons and others) who had been employed in CRS reconstruction programs and who continued to practice their trade in the program locations. The responses to this questionnaire served to corroborate the findings of the Barrier Analysis survey.

Both questionnaires were used in conjunction with a set of drawings of the hazard-resistant construction practices recommended by CRS, which were shown to participants during the interviews to prompt recall of the various practices.

In each location, the study teams were comprised of CRS country program and local partner staff who knew the communities in which CRS housing reconstruction programs had been implemented, as well as team leaders trained in carrying out a Barrier Analysis.

Below: A family is interviewed in Bangladesh. The study teams were comprised of CRS country program and local partner staff who knew the communities in which CRS housing reconstruction programs had been implemented. Photos by Charlotte Sterrett for CRS



BOX 1: THE 12 DETERMINANTS OF BEHAVIOR

- 1. Perceived positive consequences:** The **advantages** that people thought using the hazard-resistant construction practices recommended by CRS would bring. For example, some people might have seen that a connection between the rafters and galvanized iron (GI) sheets could prevent the roof from being blown off in high winds, while others may have regarded it as a decorative feature.
 - 2. Perceived negative consequences:** The **disadvantages** that people thought using the construction practices recommended by CRS would bring. For example, some people might have regarded a raised floor as a tripping hazard for elderly family members, while others may not have seen any disadvantages to living in a home with a raised floor.
 - 3. Perceived social norms:** Whether people thought they would get **approval** or **disapproval** from family, friends, neighbors and others around them for using the construction practices recommended by CRS. For example, some people might have thought that their parents would regard digging deeper foundations as a waste of time, while others may have thought that their neighbors would approve of it.
 - 4. Cues for action:** The things that helped **remind people to do something** towards hazard-resistant construction or how to do it, for example, seeing a poster with step-by-step illustrations of the recommended construction practices. Cues for action can also be powerful events that trigger a change in people's behavior, such as having their house destroyed by a typhoon and then deciding to construct a new one using typhoon-resistant construction practices.
 - 5. Perceived self-efficacy:** Whether people thought they had the **knowledge and skills** to successfully carry out the construction practices recommended by CRS. For example, some people might have felt they had the necessary skills to pack earth into a wall, while others may have felt unable to do it.
 - 6. Access:** Whether people had access to the **resources** (such as time, money, tools etc.) they needed to use the construction practices recommended by CRS. For example, some people may have been able to pay for transport to buy specific materials outside the village, while others may have considered this unfeasible.
 - 7. Perceived risk:** Whether people thought they were **at risk** if they did not use the construction practices recommended by CRS. This included two components: Firstly, whether they thought there was a **high likelihood of the problem occurring** where they lived. For example, some people may have considered that cyclones rarely affected their region and that they were unlikely to experience one, whereas others might have thought that it was likely that, in the near future, cyclones could affect their village. Secondly, whether they **considered themselves vulnerable** to the problem. For example, some people might have known that cyclones occurred in the region but they might have thought that houses inland were not likely to be substantially affected.
 - 8. Perceived severity:** How **serious** the people perceived the consequences of the hazard event to be. For example, some people might have regarded losing their home as a major loss affecting their dignity, health, well-being and livelihoods, while others may have seen it as an inconvenience requiring additional expenditure.
 - 9. Perceived action efficacy:** Whether people thought the construction practices recommended by CRS were **effective**. For example, some people might have believed that using roof ties would prevent their roof from being lifted in a typhoon, while others may have regarded the practice as useless.
 - 10. Perceived divine will:** Whether people believed their lives were influenced by **supernatural forces or religion**. For example, some people may have believed that an earthquake was a punishment from God.
 - 11. Policy:** Whether **laws or regulations (including informal ones)** influenced the ways in which people constructed their homes. For example, some people may have been aware of a bylaw governing how roof trusses must be constructed to resist wind load, while others may not have been aware of any policies that should have been taken into account when they constructed their homes.
 - 12. Culture:** Whether people thought culture (such as **history, customs, lifestyle, values, practices**) within a self-defined group influenced the ways in which people constructed their homes. Culture may be associated with ethnicity or lifestyle and often influences an individual's perceived social norms.
- Universal motivators:** While not considered a determinant, universal motivators are factors that motivate most people, irrespective of other variables. Factors include love, security, comfort, recognition, success, freedom, positive self-image, peace of mind, status, pleasure, and power.

PARTICIPANTS

The participants in the Barrier Analysis survey were heads of households who had reconstructed their homes following a disaster, but who were **not** beneficiaries of a CRS post-disaster housing reconstruction program. They were classified into two groups:

- **Users:** Non-beneficiaries who had rebuilt their homes using one or more of the hazard-resistant construction practices applied and recommended by CRS.
- **Non-users:** Non-beneficiaries who had rebuilt their homes *without* using any of the hazard-resistant construction practices applied and recommended by CRS.

In total, across the five locations, there were 212 survey participants (37 women, 175 men⁶). The number of participants varied in each location, and while CRS strived to find a similar number of users and non-users, this was not possible in Bangladesh and India.⁷



Across the five locations, there were 212 participants —37 women, 175 men—in the survey.

TABLE 1
NUMBER OF USERS/NON-USERS INTERVIEWED IN EACH LOCATION

Country	Users: Those who used the hazard-resistant practices	Non-users: Those who did not use the hazard-resistant practices	Total interviewed
Bangladesh	23	12	35
India	27	12	39
Madagascar	17	19	36
Pakistan	42	41	83
Philippines	11	8	19
TOTAL	120	92	212

ANALYSIS PROCESS

The Designing for Behavior Change methodology and Barrier Analysis require a comparison of the data collected from the two groups, users and non-users, to understand what prevented the non-users from being users.

In each location, responses to each question or set of questions relating to a particular determinant were coded, calculated as a percentage of each group size, and compared. Where there was a difference of 15 to 25 percent, (depending on the total number of participants⁸) between the responses of the users and non-users, the determinant to which the question(s) related was considered significant in terms of enabling or preventing adoption of the hazard-resistant construction practices in that location.

Factors that enabled users to overcome barriers or prevented

6. Barrier Analysis requires interviews to be conducted with the main decision-maker about the behavior or practice being studied. While men were generally regarded as the heads of households in most of the study's locations, the study team endeavoured to speak with as many women as possible, either along with their husbands/partners or as single heads of households.
7. The recommended sample size for a Barrier Analysis survey is approximately 100 participants (50 users and 50 non-users). In this study, the number of identifiable users in CRS' program area defined the total sample size. In addition, across the five locations, 21 skilled laborers (all men) were interviewed using the complementary questionnaire. Bangladesh = 1; India = 4; Madagascar = 5; Pakistan = 6; Philippines = 5
8. In Barrier Analysis, a 15 percent difference is normally regarded as 'significant'. In this study the percentage difference was adjusted to 20 percent (Bangladesh, India, Madagascar) and 25 percent (Philippines) to compensate for smaller sample sizes.

non-users from overcoming barriers were identified in each location using the responses to the additional questions relating to household income sources, land tenure and house ownership, gender, assistance provided by other organizations, and knowledge of a CRS program.

To generate a **multi-country perspective** on the relative significance of each determinant, the results for each location were collated and interpreted in the following way:

- Determinants that were considered **significant in four or five locations** were classified as **'very significant** to the adoption of hazard-resistant construction practices'.
- Determinants that were considered **significant in three locations** were classified as **'significant** to the adoption of hazard-resistant construction practices'.
- Determinants that were considered **significant in two locations** were classified as **'moderately significant** to the adoption of hazard-resistant construction practices'.
- Determinants that were considered significant in one or no locations were classified as **'less significant** to the adoption of hazard-resistant construction practices' according to this study.

Common enabling factors and barriers across the five locations were identified, as well as other issues that may have influenced the results at this level, such as CRS program design and implementation processes.

Finally, recommendations to overcome common barriers and reinforce common enabling factors were identified for application by CRS and other organizations in disaster risk reduction and post-disaster reconstruction programs.

.....
Determinants that were considered significant in four or five locations were classified as 'very significant to the adoption of hazard-resistant construction practices'.
.....

Program information

The CRS approach to housing reconstruction is based on *six principles* that increase household resilience to disasters. All of the principles were followed in each of the five locations of this study.

- 1. Community-based:** CRS uses local materials, technologies and skills whenever possible. It consults local skilled laborers and members (male and female) of disaster-affected households in the design of its programs to ensure they are culturally appropriate and respond to local needs.
- 2. Market-based:** CRS assesses the strength of local economic markets. If markets are healthy enough, it provides people with cash or vouchers to buy materials and hire laborers locally. When direct distributions are necessary, CRS strives to buy locally available goods and services.
- 3. Tailored:** CRS collaborates directly with affected communities to ensure that the homes constructed fit the context of each disaster. It constructs demonstration homes and requests feedback from community members to make sure final designs are appropriate.
- 4. Safe and durable:** To ensure CRS-supported homes withstand future disasters, CRS strives to improve local designs and knowledge by providing technical assistance and capacity-strengthening of local skilled laborers.
- 5. Integrated:** CRS integrates its housing programs with activities to restore livelihoods, improve water and sanitation, protect highly vulnerable people, and help communities become more resilient to future disasters.
- 6. Accountability to beneficiaries:** CRS incorporates appropriate ways to advise communities of project activities, beneficiary criteria and selection, and establishes beneficiary feedback mechanisms in all of its emergency response programs.

.....
CRS collaborates directly with affected communities to ensure that the homes constructed fit the context of each disaster.
.....



Photo by Jennifer Hardy for CRS

Bangladesh

- Hazard type:  Cyclone Aila
- Date of event:  25 May 2009
- Program duration:  2 years
- Beneficiaries:  1,500 households
- Cost per home:  US\$957
(\$913 materials, \$44 labor)



Training provided

Beneficiaries and local carpenters were trained to use the building practices correctly.



Information provided to the community

- A demonstration home was built within the community to familiarize non-beneficiaries with disaster-resistant construction practices.
- An illustrated brochure of the design and building practices being used in CRS beneficiary homes was provided to neighboring non-beneficiary communities so people could learn about the building practices replicate them independently.



Construction practices applied to increase cyclone resistance



Foundation: Column sunk into ground



Column-to-beam connections: Bolt cast into column



Raised floor level: Raised plinth, plinth protection



Walls: Cross bracing



Column: Reinforced concrete



Roof: Securely fixed

Construction materials* provided

- Reinforced concrete pillars; timber for roof beams; roof sheeting; nuts, bolts and screws; bamboo poles for walls, door and windows; and plastic sheets as temporary wall covering until the mud walls were completed.

*Most of these materials were available locally.



Photo: Isaac Boyd

India

- Hazard type:  Floods
- Dates of events:  June and September 2008
- Program duration:  2 years
- Beneficiaries:  157 households
- Cost per home:  US\$587
(\$543 materials, \$44 labor)



Training provided

Establishment of village disaster management committees which acted as the key decision-making bodies at the local level; responsible for the selection of beneficiaries, the safekeeping of shelter construction material, and the monitoring of shelter work in the village.



Construction practices applied to increase flood resistance



Foundation: Column sunk into ground



Column-to-beam connections: Bolt cast into column



Raised floor level: Raised plinth



Walls: Cross bracing



Columns: Reinforced concrete



Roof: hipped

Information provided to the community

- A demonstration home was built in the community to familiarize beneficiaries and non-beneficiaries with disaster-resistant construction practices.
- An illustrated brochure of the design and construction practices being used in CRS beneficiary homes was provided to non-beneficiary communities so people could learn about the construction practices and replicate them independently.



Construction materials* provided

Depending on the design, prefabricated concrete pillars or compressed stabilized earthen blocks were provided, along with chicken wire and cement mortar for plinth reinforcement.



Photo: Isaac Boyad

*All of these materials were available locally.

Madagascar

Hazard type:  Cyclone Giovanna

Date of event:  February 2012

Program duration:  10 months

Beneficiaries:  260 households

Cost per home:  US\$155
(\$125 materials, \$30 labor)

Mozambique

Indian Ocean

Madagascar

-  Brickaville district (Atsinanana)
-  Vatomandry district (Atsinanana)
-  Farafangana district (Atsimo-Atsinanana)
-  Vondrozo district (Atsimo-Atsinanana)

Additional activities



Cash-for-work and food-for-work for community clean-ups



Provision of agricultural rehabilitation kits (seeds and tools); seed fairs

Information provided to the community

A poster illustrating the construction practices was displayed in a public place in each village (*fokontany*).



Construction practices used to increase flood and cyclone resistance



Foundation: Column sunk into ground; sealed with engine oil



Column-to-beam connections: Metal strapping



Raised floor level: Stabilized floor plates



Roof: Braced trusses



Walls: Cross bracing



Roof structure connections: Timber noggings

Training and materials* provided

- A demonstration home was built to pilot construction practices and as a demonstration for program staff.
- Leaflets illustrating the construction practices were provided to all construction teams (comprised of 10 people including 1 skilled carpenter, beneficiary household members and others).
- On-the-job training by housing engineers was offered to construction teams.

* Only materials that were not available at the village level (nails, milled hardwood for foundations and frame, stones for foundations) were provided.



Photo: CRS staff

Pakistan

- Hazard type:  Floods
- Date of event:  September 2012
- Program duration:  3.5 years
- Beneficiaries:  5,304 households
- Cost per home:  US\$436
(\$420 materials, \$10 labour, \$6 transportation)



Training provided

- Program staff were trained on the importance and proper raising of a plinth as a prerequisite for each community before housing kits were distributed and as a key DRR element designed to protect homes from flooding in the future.
- Beneficiaries were trained on where to source the mud for construction to ensure that it was of good quality, was taken from unused, non-agricultural land and that removal would not create new hazards within the community.
- Skilled laborers were trained on the flood-resistant housing structure design and construction and the Operation and Maintenance Training Guidance Manual, including recommendations to prevent insect attack to timber and bamboo.

Information provided to the community

- One demonstration home was built in each community to familiarize beneficiaries with hazard-resistant practices.
- A brochure with photos, sketches and explanatory text was distributed to beneficiary and non-beneficiary households
- A banner showing the hazard-resistant construction practices was displayed in each community.



Construction practices applied to increase flood resistance



Foundation: Column sunk into ground



Walls: Protected with lime



Floor: Raised plinth



Roof: Angled



Column-to-beam connections: Rubber strapping



Roof structure connections: Beam to purlin

Construction materials* provided

- Poplar for roof beam, bamboo for columns and rafters, chick mats (woven natural fiber) for roof and wall, plastic sheets, rope, nails, tire tubes and tools.
- Communities contributed in kind by raising a plinth for the housing.



Photo: Jennifer Hardy

* All materials were available locally or regionally.

Philippines

Hazard type:  Typhoon Bopha

Date of event:  December 2012

Program duration:  9 months

Beneficiaries:  4,129 households

Cost per home:  US\$459
(\$380 materials, \$79 labor)



Training provided

- Half-day initial orientation plus on-the-job training for 70+ carpenters.
- Briefing on construction practices to be used for beneficiary household members.
- Five demonstration houses constructed per neighborhood 'barangay' to train first group of carpenters.



Construction practices applied to increase typhoon resistance



Foundation: Reinforced concrete pad



Floor: Raised level



Column-to-beam connections: Timber noggings



Walls: Corner bracing



Roof: Securely fixed



Roof structure connections: Trusses plate; wire strapping

Information provided to the community

- One leaflet illustrating the construction practices was posted in each barangay hall.



Construction materials* provided

- Concrete and reinforcement bars for foundations; sawn lumber for frames and nails, tie-wires and galvanized iron sheets for roofing were provided.
- All materials were available locally, but chain-saw operators were in high demand, reducing the availability of sawn lumber, and there was a limited local supply of galvanized iron sheets of the specified weight.

* Most of these materials were available locally.



Photo: Seki Hirano

STRUCTURAL COMPONENTS OF HAZARD-RESISTANT CONSTRUCTION

A house that is resistant to different hazards, such as floods, cyclones and earthquakes, needs to be structurally sound. This requires that the structural components—foundations, floors, columns, walls, and roof—are carefully designed and constructed so that each is individually strong enough, and securely connected to form an overall construction that offers protection to its occupants and their belongings.

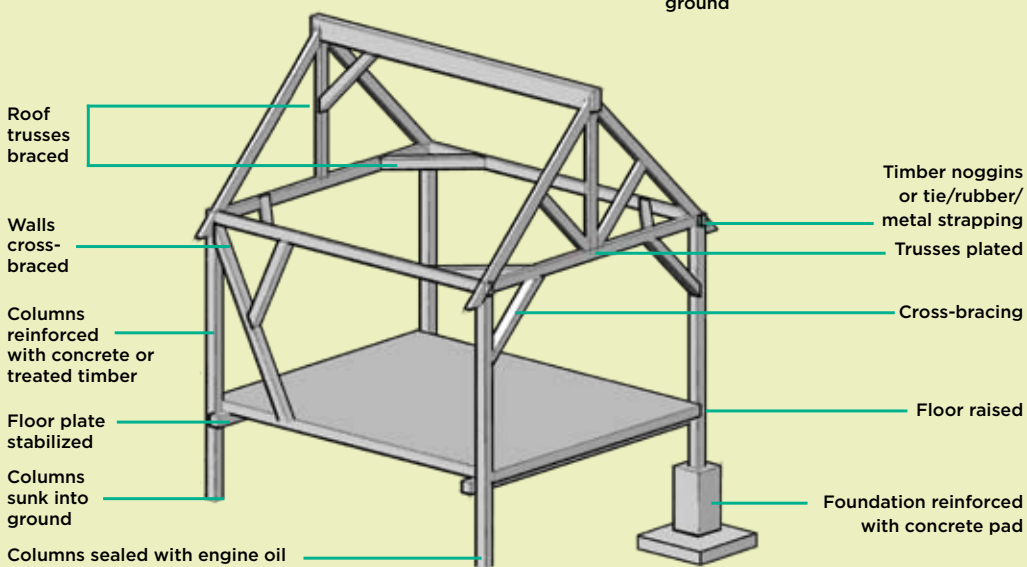
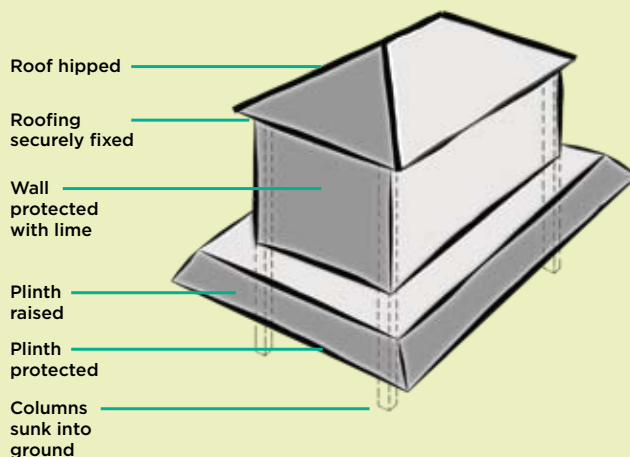

Foundations: The foundation transfers all the weight from the construction into the ground, and prevents the structure from sinking or from being blown over. It is important to consider the bearing capacity of the soil to determine the size and depth of the foundation, as well as the effects of corrosion on the foundations due to water and insects from the soil/ground. If timber posts are directly set into the ground, the timber must be protected from insect attack and rotting due to moisture. The soil under the foundations must be properly compacted to improve strength to support the foundation, and excavations around the foundation must be properly backfilled and compacted to improve strength to prevent uplift.

Floor: The floor is where people and assets occupy space; if water penetrates the house, household items can be damaged and the floor structure weakened. It is important to consider raising the floor level above flood levels. The floor is usually supported by beams that transfer the load onto columns and walls.

Walls and columns: The walls and columns are the elements that create the home's living space and support to the roof. All loadings on the construction, e.g. wind forces, weight from each floor/level, are















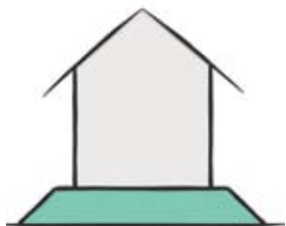

transferred through these vertical elements into the foundations and then, into the ground. For areas where wind or earthquake pressure is significant, reinforcing the walls through cross-bracing increases the strength of the house to withstand these lateral forces.

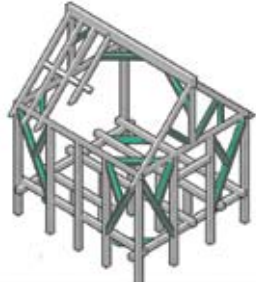
Roof: Roof trusses are the main structures supporting loadings on the roof, e.g. uplift forces created by wind, and downward forces from the weight of snow, etc. The roof cover is fixed onto purlins that transfer the roof load to the trusses. Appropriate shape and slope of the roof can minimize the effect of uplift forces on the construction. Adding bracing to the trusses and securely fixing the roof can prevent damage to the house.

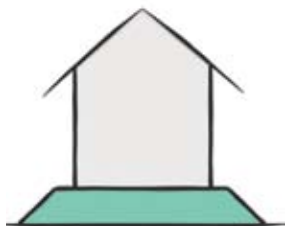
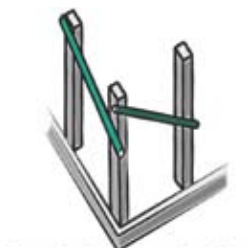







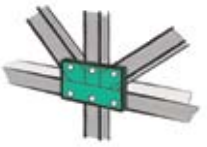

Connections: All the above elements must be securely connected together from roof to columns to walls to foundations, to ensure that forces can be transferred from one element to another and then down to the ground.

A matrix of all hazard-resistant construction practices used in the locations studied is included in the following pages.

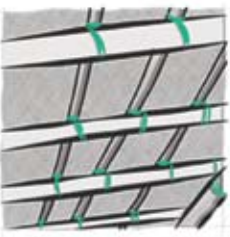
HAZARD-RESISTANT CONSTRUCTION PRACTICES RECOMMENDED BY CRS

	FOUNDATIONS	RAISED FLOOR LEVEL	WALLS	COLUMNS
PHILIPPINES	<p>REINFORCED CONCRETE PAD</p> 	<p>RAISED FLOOR</p> 	<p>CORNER BRACING</p> 	<p>NA</p>
PAKISTAN	<p>COLUMN SUNK INTO GROUND</p> 	<p>RAISED PLINTH</p> 	<p>PROTECTED WITH LIME</p> 	<p>NA</p>
MADAGASCAR	<p>COLUMN SUNK INTO GROUND</p> 	<p>STABILIZED FLOOR PLATES</p> 	<p>CROSS-BRACING</p> 	<p>COLUMN SEALED WITH ENGINE OIL</p> 
INDIA	<p>COLUMN SUNK INTO GROUND</p> 	<p>RAISED PLINTH</p> 	<p>CROSS-BRACING</p> 	<p>REINFORCED CONCRETE COLUMNS</p> 
BANGLADESH	<p>COLUMN SUNK INTO GROUND</p> 	<p>RAISED PLINTH</p> <p>PLINTH PROTECTION</p> 	<p>CROSS-BRACING</p> 	<p>REINFORCED CONCRETE COLUMNS</p> 

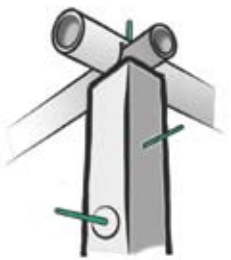
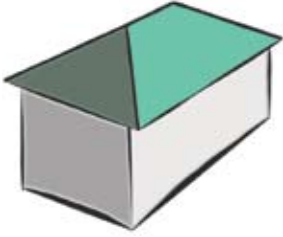
HAZARD-RESISTANT CONSTRUCTION PRACTICES RECOMMENDED BY CRS

	COLUMN-TO-BEAM CONNECTIONS	ROOF STRUCTURE CONNECTIONS	ROOF
PHILIPPINES	<p>TIMBER NOGGIN</p> 	<p>PLATED TRUSSES</p>  <p>WIRE STRAPPING</p> 	<p>SECURELY FIXED ROOFING</p> 
PAKISTAN	<p>RUBBER STRAPPING</p> 	<p>BEAM-TO-PURLIN</p> 	<p>ROOF ANGLED</p> 
MADAGASCAR	<p>METAL STRAPPING</p> 	<p>TIMBER NOGGIN</p> 	<p>ROOF TRUSSES BRACED</p> 
INDIA	<p>BOLT CAST INTO COLUMN</p> 	<p>NA</p>	<p>HIPPED ROOF</p> 
BANGLADESH	<p>BOLT CAST INTO COLUMN</p> 	<p>NA</p>	<p>SECURELY FIXED ROOFING</p> 

Results

This section contains the multi-country findings for each determinant, starting with those that were found to be **very significant**, and ending with those that were found to be **less significant** in the locations where the study was carried out.

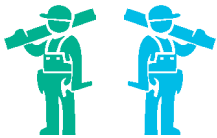

For the determinants found to be **very significant** in the locations where the study was carried out, the findings are illustrated with infographics showing where there was a *difference* of 15 to 25 percent* between the responses of users and non-users.



For the determinants found to be **less significant** in the locations where the study was carried out, the findings are illustrated with infographics showing where there was a *similarity* among the responses of users and non-users.

For each determinant, strategies and activities are recommended for CRS and other organizations to increase the adoption of hazard-resistant construction practices in communities at risk of disasters, both in post-disaster settings and in disaster risk reduction programs.

* Divergence was defined as a difference of more than 25% in the Philippines; more than 20% in India, Madagascar and Bangladesh; and more than 15% in Pakistan.

.....
For each determinant, strategies and activities are recommended for increasing the adoption of hazard-resistant construction practices in communities at risk of disasters.
.....



Jeanne Marie, 81, in her new CRS-built home in the village of Namahaoka, Madagascar, built after Cyclone Giovanna toppled her previous home. Photo by Sara A Fajardo for CRS

CUES FOR ACTION

CRS actively used the following means to influence households outside its target beneficiary group to promote replication of the hazard-resistant construction practices:

- **Demonstration homes**
- **Briefing sessions**
- **Posters and leaflets with images of the construction practices**
- **Training for local skilled and unskilled laborers in the hazard-resistant practices**

The results of the study indicate that *cues for action* was a very significant determinant of disaster-affected households' behavior with regard to the adoption of the hazard-resistant construction practices recommended by CRS during the reconstruction process. Being reminded of the need for hazard-resistant construction practices and how to follow them significantly affected how non-beneficiaries reconstructed their homes.

Of the variety of cues for action deliberately used by CRS, observing the construction of a CRS demonstration home was the most influential. In addition, seeing a neighbor's home reconstructed with support from CRS proved to be an unexpectedly effective cue for action. As shown in the figures below, many more users than non-users in **Bangladesh, Pakistan** and **Madagascar** specifically stated that these particular cues encouraged them to incorporate the hazard-resistant construction practices when reconstructing their own homes.

CUES FOR ACTION

The things that help remind people to do something



towards hazard-resistant construction or how to do it. For example, seeing a neighbor's home being built using hazard-resistant construction practices recommended by CRS. Cues for action can also be powerful events that trigger a change in people's behavior, such as having their home destroyed by a typhoon and then deciding to construct a new one using typhoon-resistant construction practices.

Recommendations by skilled laborers and community leaders and/or program staff also served as cues for action to use the hazard-resistant practices. As shown in Table 2, in all of the locations where skilled laborers were interviewed, a high proportion reported that they had obtained a homeowner's agreement for the construction using one or more of the hazard-resistant practices recommended by CRS. In the **Philippines**, users who took the initiative to talk to carpenters working on CRS homes highlighted the value of this interaction.

Contrary to expectations, posters or leaflets illustrating hazard-resistant practices were not identified as important cues for action by users or non-users in any of the study locations. This, however, may be attributed to issues of design, or the locations and timing of their distribution.

TABLE 2
PERCENTAGE OF SKILLED LABORERS WHOSE PRACTICE RECOMMENDATIONS WERE TAKEN UP BY HOMEOWNERS

Location	Percentage of skilled laborers
India	100%
Pakistan	100%
Philippines	75%
Madagascar	67%



A high proportion of skilled laborers said they had obtained a homeowner's agreement to use hazard-resistant practices recommended by CRS. Photo by Seki Hirano for CRS

RESULTS OF BARRIER ANALYSIS RELEVANT TO CUES FOR ACTION

'What have you seen or heard about that helped you decide how to reconstruct your home?'

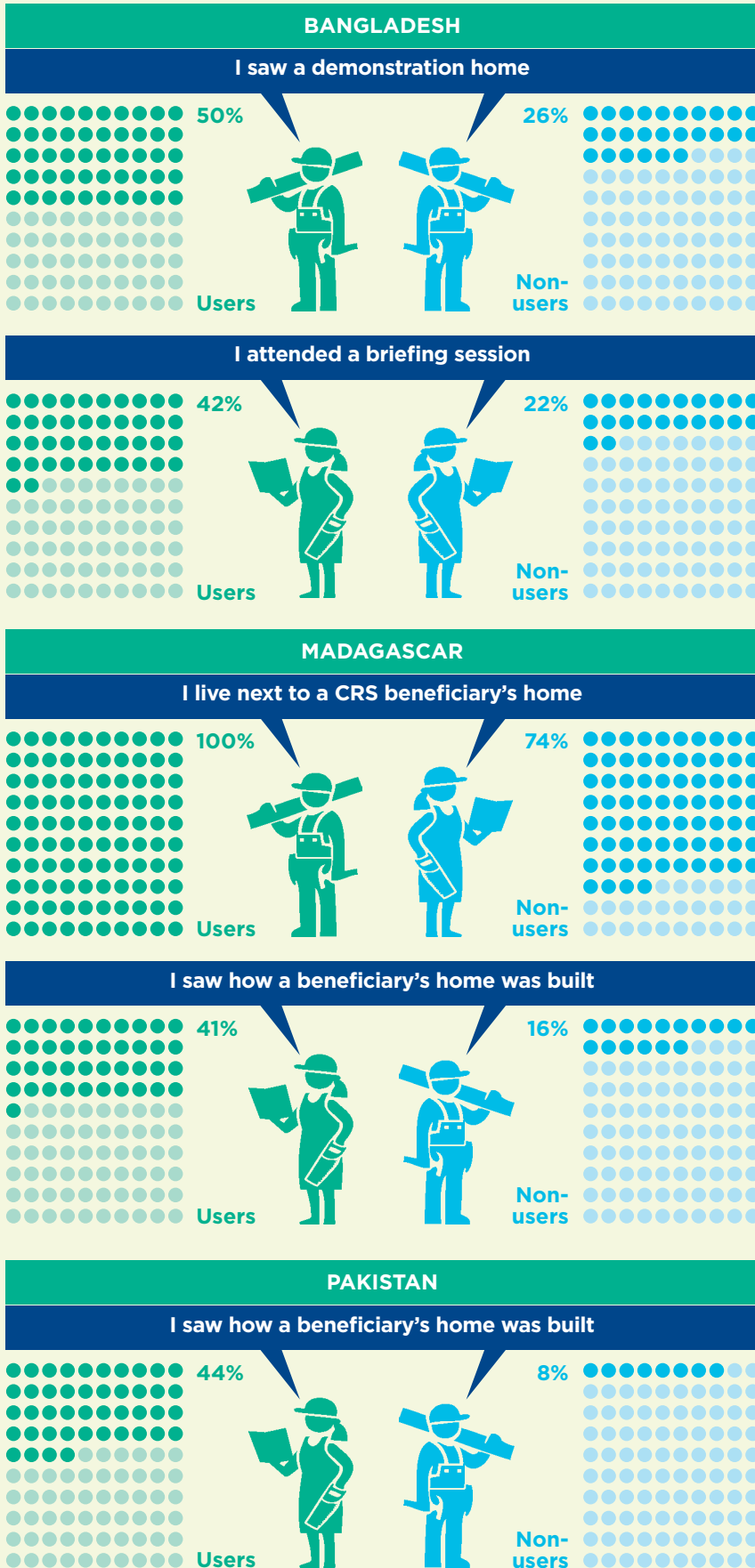

KEY

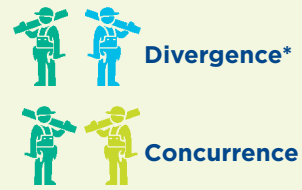

* Philippines More than 25%.
 India, Madagascar and Bangladesh More than 20%.
 Pakistan More than 15%.



One day, my brother took me to see a house built by Balasore Social Service Society [a CRS-funded partner]. Based on what I saw, I decided to build a stronger house.

Sangita Das
 Langaleswar village
 Balasore, India



SUGGESTED STRATEGIES AND ACTIVITIES TO REINFORCE AND DEVELOP CUES FOR ACTION

To maximize the impact of cues for action, organizations such as CRS should consider the following:

1. Construct more demonstration homes within communities.

- Ensure the presence of a project representative during construction of demonstration homes, so that the hazard-resistant practices, their benefits and costs, can be explained to people who show interest in the demonstration home.
- Highlight the recommended construction practices in demonstration homes using colored paint on the structure, to attract visitors' attention to important features.
- With the permission of the homeowners, use homes being built by CRS as locations for community briefings on risks, including the effects of climate change, and how to reduce them through hazard-resistant construction practices.
- Provide clearly illustrated leaflets and posters at demonstration homes and the homes of CRS beneficiaries, as well as to skilled laborers who participate in the project, to explain how to follow the construction practices, how much each costs, and the benefits.
- Construct demonstration homes in prominent places, such as on regularly used roads and in market places so that they can be seen more easily.
- Organize exchanges for men and women of neighboring villages to see demonstration homes and participate in awareness-raising activities.

2. Create opportunities for people to learn about hazard-resistant practices.

- Explore the impact of popular audio-visual media, such as community radio or theatre, to complement printed materials such as leaflets and posters.
- Time the use of media-related cues for action to coincide with periods when most people construct or reconstruct, such as after harvests, on paydays, and on days with special significance (religious/spiritual/anniversary of disaster).
- Include role-plays in training sessions to encourage skilled and unskilled laborers and other locally relevant influencing groups to recommend hazard-resistant practices using information about their effectiveness and cost.

3. Ensure that the timing of post-disaster housing reconstruction programs aligns with affected peoples' desire to reconstruct as soon as possible after the disaster.

- Increase investment in disaster preparedness, so that locally relevant designs incorporating the practices, as well as materials, technical support and communications plans, can be mobilized at short notice.
- As soon as communities start reconstruction following a disaster, set up highly visible help desks in communities for people who have queries about hazard-resistant practices, with skilled laborers who can accompany enquirers to their houses to provide hands-on advice.
- Construct demonstration homes as early as possible after a disaster, to ensure that those who reconstruct their homes very quickly are able to see the recommended hazard-resistant practices before they start.



When I found out that we had not met the criteria to receive a house from CRS, I visited my relatives who were already having their house built by CRS and asked them about the practices. I also asked the CRS carpenters working there to give me advice and measurements for the foundations, bracing and connections.

Roger Dacles
Mangayon village,
Compostela Valley,
Philippines





In the Philippines, users of the cyclone-resistant construction practices tended to have two or more income earners per household. Photo by CRS Staff

ACCESS

The results of the study indicate that access to resources was a significant determinant of disaster-affected households' behavior with regard to the adoption of the hazard-resistant construction practices recommended by CRS during the reconstruction process.

While a large proportion of user and non-user households in all locations found it difficult to pay for or obtain the resources required for the hazard-resistant practices, access to resources was a major barrier to safer reconstruction in **India, Madagascar** and the **Philippines**. In these locations more non-users than users said that they found it 'very difficult' to pay for or obtain the materials and skilled labor required to use the hazard-resistant practices. In the other two locations, access did not appear to be a significant determinant, or other determinants were of equal importance.

A variety of factors that enabled users to overcome difficulties related to access to resources were identified during the study.

In **Bangladesh**, many users of the flood-resistant construction practices took out a loan from a credit union or other moneylender, which they repaid later from income from a variety of sources (for example, small business, the sale of livestock, manual labor, fishing). They were also more likely to have participated in cash-for-work programs set up by other NGOs immediately after the disaster.

In **India**, users of the flood- and cyclone-resistant construction practices tended to have two or more income earners in the household. Users also tended to include members working in waged labor, whereas non-users tended to rely solely on subsistence farming. Many users drew on savings they had accumulated before the disaster to pay for reconstruction, while some saved up gradually after the disaster in order to buy the necessary

ACCESS

Whether people have access to the resources they need to use the construction practice. In post-disaster reconstruction contexts, aspects of **access to resources** that affect the decisions people make with respect to reconstructing their homes include:



- Cost of buying or obtaining construction materials while still trying to recover from losses that affect household income.
- Availability of local construction materials (in the natural environment and markets).
- Availability of skilled laborers, and the cost of labor in relation to income and basic household needs.
- Physical ability to collect and transport materials.
- Gender relations that affect the ability of men and women to negotiate for and buy materials and labor.

materials. Assistance in the form of cash transfers and/or materials from national government also played a role in increasing some users' ability to reconstruct using hazard-resistant construction practices.

In **Madagascar**, users of the cyclone-resistant construction practices were more likely to have taken on additional work after the disaster, such as making and selling charcoal or as casual laborers. Users were also more likely to have planted and sold cash crops to buy materials and pay carpenters to reconstruct their homes.

In **Pakistan**, users of the flood-resistant construction practices tended to have sold livestock in order to build directly after the floods, or waited until the next harvest to reconstruct their homes.

In the **Philippines**, users of the cyclone-resistant construction practices tended to have two or more income earners per household, and to have small businesses, such as a bakery or grocery kiosk in addition to farming.

Across the five locations of the study, the main factors that prevented non-users from overcoming barriers related to access to resources included being in a single-headed household and relying solely on subsistence farming/fishing livelihoods.

In all of the five locations, CRS' primary objective was to provide program beneficiaries with a home that met Sphere housing and settlement minimum standards⁹ for covered living space and construction, within the shortest possible timeframe. However, the unit cost of one CRS home exceeded the amount that many disaster-affected households perceived they could afford for reconstruction, which explains why many non-beneficiaries did not use all, or even some, of the hazard-resistant construction practices. For example, in Madagascar each home cost CRS US\$155 to construct, equivalent to the cost of 250 kilograms of rice. Not surprisingly, many non-beneficiary users of the construction practices took between 6 and 18 months to pay for the materials and labor they required to reconstruct their homes.



Photo by Laura Sheahan for CRS

In Pakistan (above), users of the flood resistant construction practices tended to have sold livestock in order to build directly after the floods or waited until the next harvest to reconstruct their homes.

TABLE 3
UNIT COST OF CRS HOME

Location	Unit cost of CRS home (US\$) ¹⁰
Bangladesh	\$957
India	\$587
Madagascar	\$155
Pakistan	\$436
Philippines	\$459

9. *The Sphere Handbook* provides one of the most widely known and internationally recognized sets of common principles and universal minimum standards in life-saving areas of humanitarian response. The Sphere Project is a voluntary initiative that brings a wide range of humanitarian organizations together with the common aim of improving the quality of humanitarian assistance and the accountability of humanitarian organizations to their constituents, donors and affected populations. The Sphere Project (2011) *The Sphere Handbook: Humanitarian Charter and Minimum Standards in Humanitarian Response*. Rugby, UK: Practical Action Publishing.

10. Differences in cost across countries are due to different construction materials (for example, concrete versus wooden columns) and the method of payment (for example, payment to skilled laborers versus in-kind contribution of labor in exchange for food).

RESULTS OF BARRIER ANALYSIS RELEVANT TO ACCESS
 'How difficult was it to pay for hazard-resistant practices?'

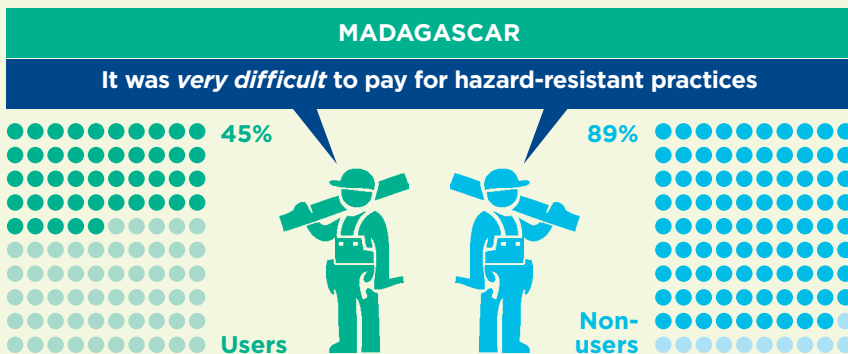

KEY

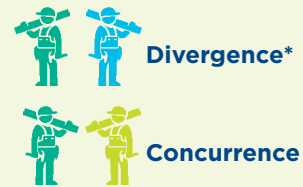

* Philippines More than 25%.
 India, Madagascar and Bangladesh More than 20%.
 Pakistan More than 15%.



I am happy now that we have a safer home, but worry about how we will continue to pay back the loan we took out to rebuild our home.

Sabita Rani Mondol
 Munshiganj village
 Satkhira, Bangladesh



Additional questions relevant to access to resources

- ‘How did you meet the cost of reconstructing your home?’
- ‘Did you receive any emergency assistance from another organization?’
- ‘How many people in this household earn an income?’
- ‘What kinds of work do the income earners in this household do?’
- ‘Is this a single-headed household?’

BANGLADESH

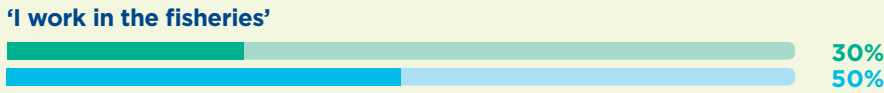

INDIA



MADAGASCAR

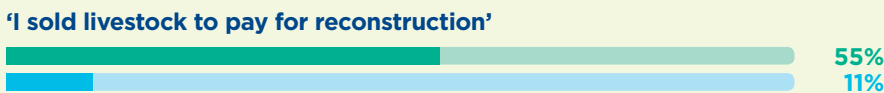
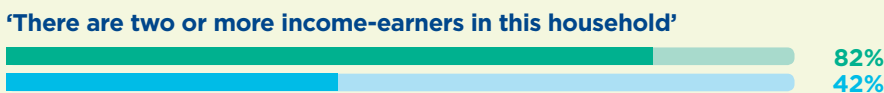

PHILIPPINES



KEY

DIVERGENCE*

- Users
- Non-users

CONCURRENCE

- Users
- Non-users

* Philippines More than 25%.
India, Madagascar and Bangladesh More than 20%.
Pakistan More than 15%.

SUGGESTED STRATEGIES AND ACTIVITIES TO INCREASE ACCESS

To overcome the barriers related to perceived limited access to resources, organizations such as CRS should consider the following:

1. Use a lower-cost, easily replicated model for CRS-built homes.

- Design models on locally appropriate adaptations of construction practices based on locally available materials that can be bought at very low cost and that require minimal technical expertise to construct.
- Keep the hazard-resistant construction practices as simple as possible without jeopardizing the structural integrity.
- Create and disseminate information, education and communication (IEC) materials that use easy-to-understand images of hazard-resistant construction practices with different costs, so that households can make informed decisions based on their available budget.

2. Increase households' capacity to buy materials and labor immediately after a disaster and through long-term livelihood interventions.

- Provide conditional cash grants or vouchers for specific items (such as hardwood corner posts and metal hardware). Grants/vouchers could be distributed following attendance at a demonstration session or upon completion of specific stages of construction. If contextually appropriate, beneficiaries could use their vouchers at a 'building materials fair', planned by the program. This activity would be suitable in a post-disaster setting or as part of a longer-term development program.
- Consider cash-for-work programs or loans for post-disaster recovery to boost income, and link these with awareness-raising on the benefits of hazard-resistant construction practices.
- Establish savings clubs or micro-insurance schemes in disaster-prone areas, so that affected households are better prepared for situations when repairs and reconstruction are required.
- Provide additional support to highly vulnerable households, such as single-headed households, those headed by elderly people, and those that include people living with disabilities.
- Link projects to promote hazard-resistant housing with longer-term food security and livelihoods projects in the same area. Win-win strategies would include raising awareness of the impact of reconstruction-related expenses on food and income security, and encouraging people to use increases in their income, as a result of more productive livelihoods, to invest in construction practices that reduce the likelihood of future income losses.
- Communicate the different costs of hazard-resistant construction practices so that households can plan their construction according to their budget.

3. Increase the capacity of households to access locally available materials and skilled labor.

- Explore ways to increase the availability of hazard-resistant construction materials in the local market by supporting local manufacturers to produce construction components of an adequate quality such as reinforced concrete columns.
- Increase the number of locally skilled workers with hazard-resistant construction skills through training programs.
- Inform households of the possibility of a phased approach to carrying out the improvements. Consider that household incomes may recover over time and aspects that they did not consider important before (like hazard-resistant practices) could be reconsidered later in the recovery process.



I saw the CRS carpenter soaking the wooden posts in engine oil, setting them deep in the earth and pressing down the earth and stones around them, but I could not afford those extra materials. I had some savings from before the cyclone but that was not enough. It took me over a year to save up the rest from selling milk and corn.

Zafy Perline
Manahoaka village
Brickaville, Madagascar





Rahima Begum works on building the raised plinth of her future home in southern Bangladesh. Photo by Jennifer Hardy for CRS

PERCEIVED RISK

The results of the study indicate *perceived risk* was a significant determinant of disaster-affected households' adoption of the hazard-resistant construction practices recommended by CRS and its partners during the reconstruction process.

In three locations—**India**, **Pakistan** and **Madagascar**—more users than non-users perceived that a hazard was very likely to affect the area where they lived in the next five years and that inadequate construction practices would make their home vulnerable to it. In the other two locations, **Bangladesh** and the **Philippines**, there was no marked difference between users' and non-users' perceptions of the risk of having their home destroyed in a future flood or typhoon.

Perception of high risk therefore appears to have been an enabling factor with regard to the adoption of the hazard-resistant construction practices recommended by CRS, and perception of low risk appears to have been a barrier.

PERCEIVED RISK

Whether people think they are **at risk of having their home destroyed**



if they do not use certain hazard-resistant construction practices. In the context of disaster risk, this includes two components: Firstly, whether people think there is a **high likelihood of a hazard occurring** where they live; and secondly, the extent to which they **consider themselves vulnerable** to the problem. For example, some people may use reinforced concrete columns to strengthen and stabilize their home because they believe a future cyclone is very likely, and that their home is vulnerable if they do not use this practice.

RESULTS OF BARRIER ANALYSIS RELEVANT TO PERCEIVED RISK

- ‘How likely is it that a flood/cyclone/typhoon will affect this area in the next five years?’
- ‘Why was your previous home destroyed in the last flood/cyclone/typhoon?’

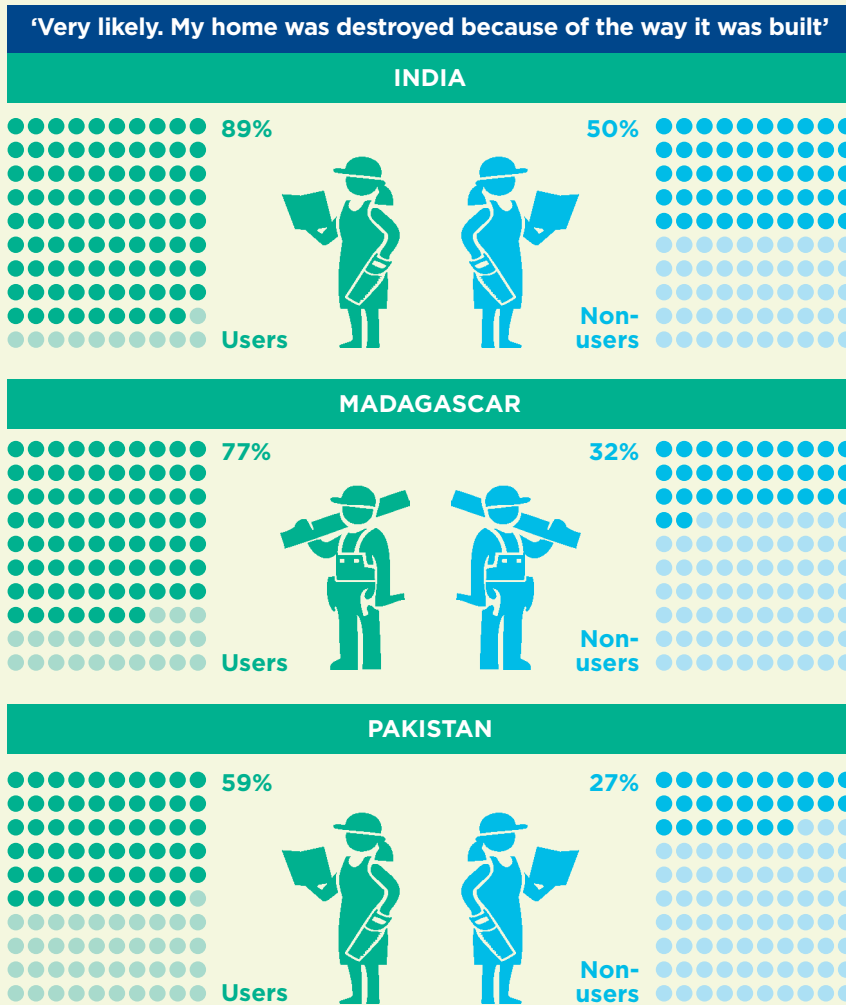

We have learned from our experience of the flood. Nowadays, flood warnings help us a lot, and we understand better about when floods might come.

Sangita Das
Langaleswar village,
Balasore, India

KEY



Divergence*



Concurrence

* Philippines More than 25%.
India, Madagascar and
Bangladesh More than 20%.
Pakistan More than 15%.

SUGGESTED STRATEGIES AND ACTIVITIES TO INCREASE PERCEIVED RISK

To overcome the barriers related to perceived risk, organizations such as CRS should consider the following:

Increase understanding among at-risk and disaster-affected households of the relationship between hazard events and construction practices.

- Use demonstration homes as focal points for community activities that include a demonstration of why different hazards happen, why they destroy people’s homes, and how to use different construction practices to reduce vulnerability. Combine these with incentives such as snacks/entertainment scheduled when heads of households can attend.
- In disaster-affected communities, use popular media and visual aids to demonstrate why homes that were constructed using inadequate practices were destroyed.
- In development, DRR and recovery programs provide training to at-risk and disaster-affected communities on present and projected impacts of climate change, including easy-to-understand, down-scaled data and information on how the intensity and frequency of relevant hazards is likely to be affected.
- Design key messages on hazard-resistant construction practices that can be disseminated via help desks as soon as spontaneous reconstruction begins. This should be combined with visits to the homes of those seeking information, to provide hands-on advice and support.
- Integrate awareness campaigns on hazard-resistant construction practices into disaster risk reduction and climate change adaptation programs.



Dukhiram Dalai and his wife Sukanti decorate the doorway of their new home, built using techniques to make it more flood resistant, in the village of Raipur in Orissa, India. Photo by David Snyder for CRS

PERCEIVED POSITIVE CONSEQUENCES

The results of the study indicate that *perceived positive consequences* was a **significant determinant of disaster-affected households' behavior with regard to the adoption of the hazard-resistant construction practices recommended by CRS during the reconstruction process.**

In three locations—**Bangladesh, Pakistan** and the **Philippines**—many more users than non-users directly associated the practices with preventing damage to the home and its contents during wind storms and floods, as well as with increased stability and durability of the structure.

In some locations, the benefits mentioned by the users were not only associated with resistance to hazards. For example, in **India** users said the hipped roof created more living space, while in **Pakistan** users said putting lime on walls prevented infestation by pests. This suggests that a perception of additional advantages may be an enabling factor in perceived positive consequences.



PERCEIVED POSITIVE CONSEQUENCES

The **benefits and advantages** people think that using the hazard-resistant construction practices will bring. For example, some people choose to reconstruct using reinforced concrete columns as they believe these will make their home stronger and more durable to extreme weather events such as cyclones.

RESULTS OF BARRIER ANALYSIS RELEVANT TO PERCEIVED POSITIVE CONSEQUENCES

‘What are the benefits of living in a house that is reconstructed using these practices?’

BANGLADESH

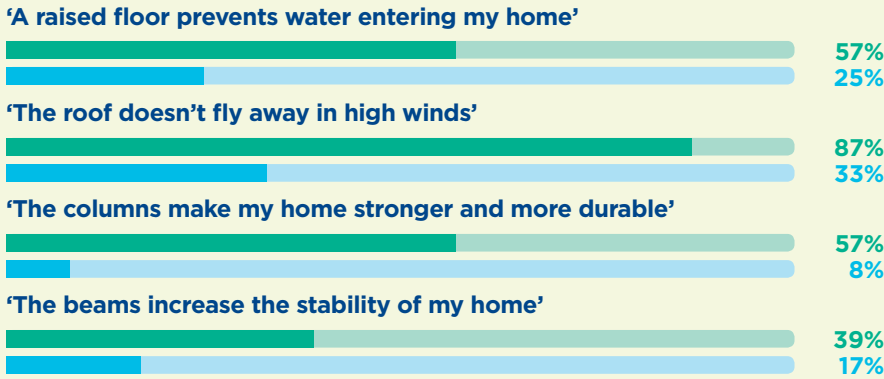

PAKISTAN

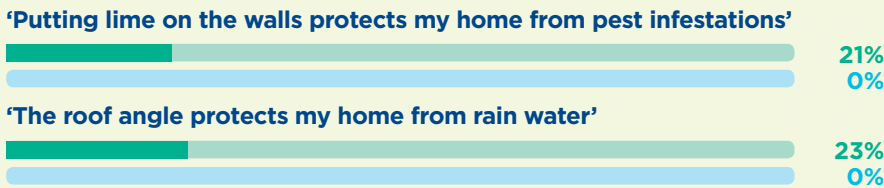

PHILIPPINES

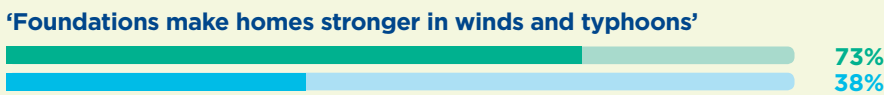

INDIA



KEY

DIVERGENCE*

- Users
- Non-users

CONCURRENCE

- Users
- Non-users

* Philippines More than 25%.
 India, Madagascar and Bangladesh More than 20%.
 Pakistan More than 15%.



I saw houses constructed by CRS with raised plinths with mud. People explained to me that raised plinths would save housing and household assets in case of any future flooding. I found this practice very useful because I had lost my house and assets in two floods.

Peer Bux
 Gulzar Kehar village,
 Jacobabad, Pakistan



SUGGESTED STRATEGIES AND ACTIVITIES TO INCREASE PERCEIVED POSITIVE CONSEQUENCES

To increase awareness of the positive consequences of using the hazard-resistant practices, organizations such as CRS should consider the following:

- 1. Reinforce knowledge within at-risk and disaster-affected communities of the advantages of hazard-resistant practices. It would be most efficient to combine this with activities to increase the availability of appropriate cues for action.**
 - Use scale models of homes and particular construction practices to show good and poor practices, e.g. a corner with and without bracing. Use these to demonstrate the effect of the hazard on the models.
 - Mainstream safer construction awareness in long-term programs (for example, DRR programs) and its outreach activities through locally appropriate approaches (theatre, puppet shows and mock drills in communities that are accustomed to visual learning and where there is no or sporadic electricity; radio bulletins, etc.).
 - Develop information, education and communications materials that include messaging on disaster-resistant construction practices that can be used in different locations. Focus messaging on options for safe construction. This could include raising awareness on poor, good, better and best practices, as any improvement is a step toward being more hazard-resistant.
- 2. Link hazard-resistant practices with universal motivators such as health and education, demonstrating that a safe and secure home provides the basis for a healthy family and a place where children are safe to do homework and learn.**
 - Develop a mass media strategy that links the use of hazard-resistant practices with universal motivators, such as ensuring children's education (for example, 'Invest in a safe home; pay less in frequent repairs / reconstruction; safeguard your children's education') or constructing a stronger livelihood ('Invest in a safe home; pay less in frequent repairs; use the savings made to grow your business').



Though I have limited resources and could not buy all of the housing material, I tried to copy the structure as much as possible. I focused on the important joints of the structure so that my house became firm and sustainable in case of flood and wind.

Jan Muhammad
Saheed Ahmed Khoso
village, Jacobabad,
Pakistan



CASE STUDY: PHILIPPINES FOOD AND EDUCATION COME FIRST

Angelita Amas and her husband cultivate a small rice field in Mangayon village, Compostela Valley, in the Philippines. They pay a small rent for the land where they live with their three children.

'Our house blew away in the typhoon but as soon as the winds had dropped my husband and I and our three children set about collecting the pieces to rebuild it. Everything we used for the new house is recycled from the old one, even the nails!' says Angelita.

'I've seen the CRS houses as some of my neighbors have them. They look good and I think the practices look easy but we couldn't afford to buy any new materials. And if we had built a stronger house we would have had to pay more rent to our landlord too. Someday I'd like to live in a better home but for now our priority is to get food on the table and finish paying for our children's education.'



Photo by Marilise Turnbull

Angelita Amas (right) is interviewed outside her house. She couldn't afford the materials needed to use the hazard-resistant construction techniques recommended by CRS.



Brothers Mashooq Khan (left) and Deedal Ali, in Pakistan's Sindh province, used CRS-taught construction skills to help others rebuild their homes after floods. Here they hold a model they used to discuss construction techniques with other beneficiaries. Photo by Jennifer Hardy for CRS

PERCEIVED SELF-EFFICACY

The results of the study indicate that *perceived self-efficacy* was a moderately significant determinant of disaster-affected households' behavior with regard to the adoption of the hazard-resistant construction practices recommended by CRS during the reconstruction process.

In all locations of the study, a high proportion of both users and non-users found some of the practices difficult to implement. However, in **India** and **Madagascar** a greater number of non-users said that they lacked the skills and knowledge to follow them, indicating that a perceived lack of self-efficacy was a barrier to usage in these locations.

In **Bangladesh** and the **Philippines**, a greater proportion of users than non-users found the practices more difficult. To understand why they persisted, it is important to consider the linkages between determinants. The results of the study suggest that users rebuilt using the hazard-resistant practices because they perceived that the positive consequences would outweigh the difficulties they experienced, and they were able to access the funds, resources and technical support they needed. The fact that the majority of users in all locations enlisted the help of relatives and paid labor for part or all of the construction process also highlights the inter-connectedness of these determinants.

Across all locations studied, the majority of both groups learned about the hazard-resistant construction practices from a CRS demonstration house, although some learned from a carpenter / mason / skilled laborer, another homeowner in the neighborhood or another village, or they already knew about the practices. None received any hands-on training on how to use the practices, which helps to explain the general perception of difficulty.

PERCEIVED SELF-EFFICACY

Whether people think they have the **knowledge and skills** to successfully carry out hazard-resistant construction practices. For example, some people may raise the floor/plinth of their home because they are confident in their knowledge and skills to complete the practices effectively.



RESULTS OF BARRIER ANALYSIS RELEVANT TO PERCEIVED SELF-EFFICACY

‘Are any of these practices difficult to follow?’

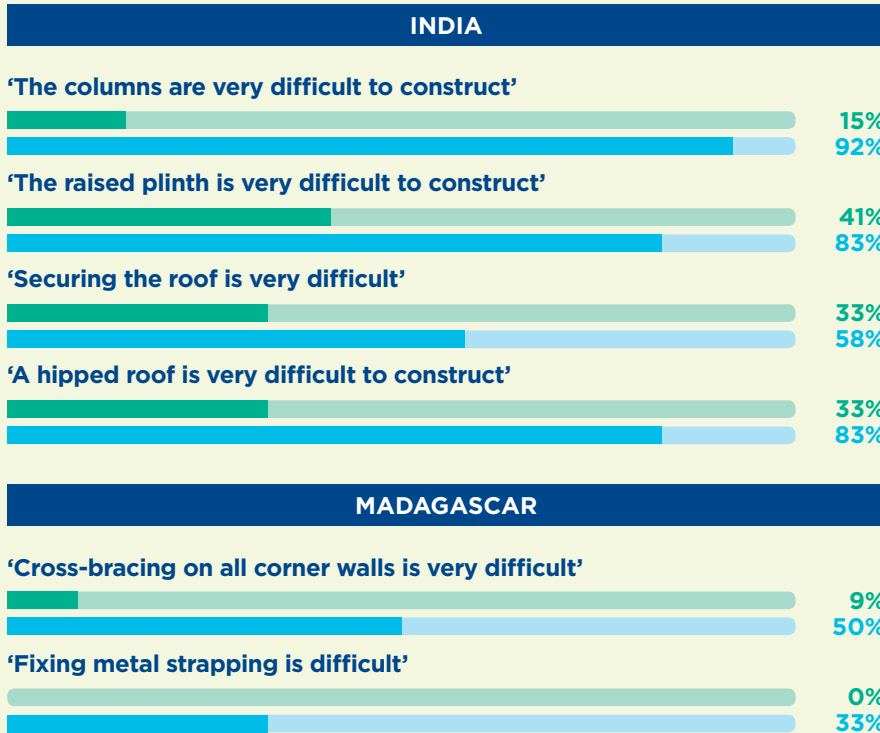

KEY



* Philippines More than 25%.
 India, Madagascar and Bangladesh More than 20%.
 Pakistan More than 15%.



The devastation of the cyclone and the reconstruction have taught us many things. We now know how important it is to have a strong house and to prepare for bad weather. We used what we learned from the program to construct a stronger home. We raised and compacted our plinth, used reinforced concrete columns that were dug deep into the ground, and used strong beams that were attached securely to the columns.

Afsar Howladar
 Jeলেখali village,
 Satkhira, Bangladesh



TABLE 4
 REASONS WHY PRACTICES WERE PERCEIVED AS DIFFICULT

Practice	Difficulty
Raised floor	• Difficult to level out
Reinforced concrete columns	• Difficult to carry and put in place due to size and weight • Difficult to dig large holes for columns
Roof beams	• Difficult to carry and put in place due to size and weight
Roof	• Difficult to measure and lay out roofing sheets correctly • Difficult to carry and put in place due to size • Difficult to cut angles correctly for four-sided, hipped roofs

SUGGESTED STRATEGIES AND ACTIVITIES TO INCREASE PERCEIVED SELF-EFFICACY

To overcome barriers related to perceived self-efficacy, organizations such as CRS should consider the following:

- 1. Support communities to build their confidence in using disaster-resistant practices by providing knowledge, skills and practical experience, both in disaster risk reduction programs in at-risk areas, and during reconstruction following a disaster.**
 - Make training and technical advice on disaster-resistant construction available for entire communities, rather than just for project beneficiaries. To build participants' confidence, promote and teach easier-to-use practices first, before introducing the more complex technical approaches.
 - Ensure that women and men access training and technical advice by providing incentives and organizing events at convenient times for both women's and men's participation.
 - Promote learning exchanges between users and non-users on how they rebuilt using the hazard-resistant practices, and tips for how to replicate them more easily by learning from the experience of others.
 - Support the creation of village help teams that can organize consultations on safer construction, and function as a catalyst for action in the community, both before and after a disaster.
 - Encourage skilled laborers to serve as a community resource by providing them with a stipend to support households to replicate the practices.
- 2. Provide clear information on simple construction practices that households can use on their own, before a disaster occurs, as part of disaster risk reduction efforts in at-risk areas.**
 - Make relevant IEC materials more accessible, user-friendly and non-technical (before and after a disaster), including information that can be used by people who may be illiterate.



Photo by David Snyder for CRS

A worker uses a hand drill to prepare beams for roof support at a CRS building site in southern Bangladesh.



Photo by CRS staff

Sangita Das decided to build a stronger home after seeing a house built by a CRS-funded partner.

CASE STUDY: INDIA FIGHTING A BATTLE

Sangita Das, 35, lives with her son and daughter in Langaleswar village, Odisha, and earns a living from sharecropping.

“My house was in a low-lying area so we had to evacuate in the middle of the night and move to a relative's house. The flood damaged all my household goods and grains. Even my hen house was damaged and I lost all my hens. After the floods I had no income and had to rely on my family for support. One day, my brother took me to see a house built by a CRS-funded partner. Based on what I saw, I decided to build a stronger house.”

Sangita used practices such as a raised plinth, reinforced concreted columns, hipped roof and wall plates in her new house to make it safer. “As I am alone I had to depend on outside labor and hence had to pay more money. I borrowed money from my brother and other relatives. I am now earning from sharecropping and I am planning to improve the house before the next monsoon. For the future, I am focusing on saving and repairing my house to reduce losses.”



A child carries water near the CRS Cyclone Giovanna recovery project in Brickaville, Madagascar. Photo by Susan Walters for CRS

PERCEIVED NEGATIVE CONSEQUENCES

Perceived negative consequences: The results of the study indicate that *perceived negative consequences* was not a significant determinant of disaster-affected households' behavior with regard to the adoption of the hazard-resistant construction practices recommended by CRS during the reconstruction process.

In all locations, the large majority of users and non-users did not find many disadvantages associated with the use of the hazard-resistant practices recommended by CRS and its partners. Where particular disadvantages were mentioned by some people in both groups, these tended to relate to concerns about durability. For example, in **Madagascar**, where parts of a home's structure that were in contact with the damp ground were periodically replaced, a number of users and non-users said that cross-bracing on corner walls and the use of sunken posts/columns made this more difficult. Similarly, in **Pakistan**, where insect infestation and rotting of columns is common, a number of users and non-users expressed their concern that having a foundation would exacerbate this problem.

In the **Philippines**, a number of users and non-users perceived that homes with raised floors were dangerous for young children and older people, as this might cause them to fall.

These issues, while not considered significant barriers to adoption, are important for organizations to consider in their design processes. Although CRS consulted local people on the suitability of possible practices for each location, it appears that some potential disadvantages were not identified.

.....



**PERCEIVED
NEGATIVE
CONSEQUENCES**

The **disadvantages** that people think using the hazard-resistant construction practices will bring. For example, some people may believe (incorrectly) that using a foundation for columns causes waterlogging.

.....

RESULTS OF BARRIER ANALYSIS RELEVANT TO PERCEIVED NEGATIVE CONSEQUENCES
 'What are the disadvantages of living in a house reconstructed using these hazard-resistant practices?'

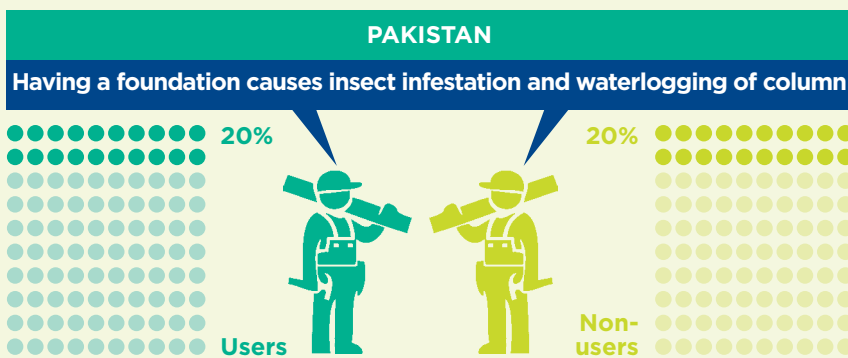
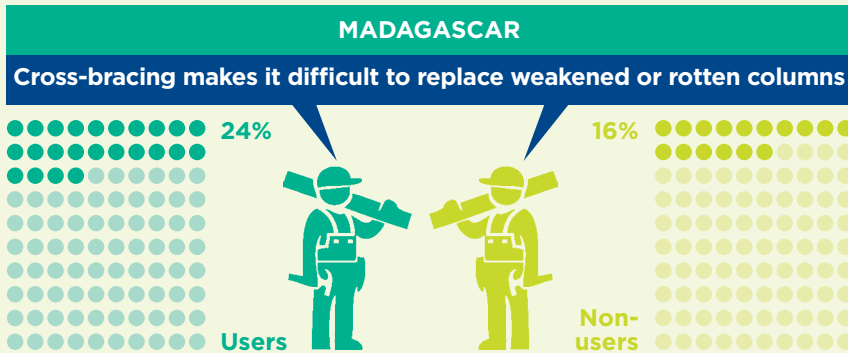

KEY

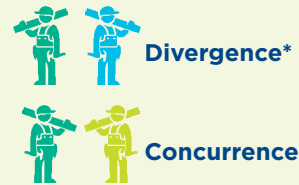

* Philippines More than 25%.
 India, Madagascar and Bangladesh More than 20%.
 Pakistan More than 15%.



As the plinth is made of earth, it might get washed away in heavy rains.

Rabea Khatun
 Jeleshali village,
 Satkhira, Bangladesh



SUGGESTED STRATEGIES AND ACTIVITIES TO REDUCE PERCEIVED NEGATIVE CONSEQUENCES

Although perception of negative consequences was not a significant barrier to the use of hazard-resistant construction practices in the locations of the study, organizations such as CRS should consider the following in all reconstruction- and housing-related DRR programs:

- 1. Base home models as much as possible on local and traditional hazard-resistant construction practices proven to be effective in previous disasters, and deemed acceptable by communities.**
 - Elicit feedback from a cross section of the community on the range of common and alternative hazard-resistant practices to be promoted through DRR or reconstruction programs. Where necessary, adapt proposed practices to ensure acceptability.
 - Seek input from sectors of the community with specific needs, such as people with disabilities, elderly people and the parents of young children, to ensure that potential dangers are mitigated.
 - Use a lower-cost, easily replicated model for CRS-supported homes that includes locally appropriate adaptations of construction practices based on locally available materials that can be bought at very low cost and that require minimal technical expertise.
- 2. Reduce negative perception of costs associated with hazard-resistant construction practices.**
 - Consider a cash-for-work program or loans for post-disaster recovery to boost income, and link this with awareness-raising on the benefits of hazard-resistant construction practices.
 - Establish savings clubs or micro-insurance schemes in disaster-prone areas, so that affected households are better prepared for situations when repairs and reconstruction are required.
 - Link projects to promote hazard-resistant housing with longer-term food security and livelihoods projects in the same area. Win-win strategies could include raising awareness of the impact of reconstruction-related expenses on food and income security, and encouraging people to use increases in their income, as they recover and livelihoods improve, to invest in construction practices that reduce the likelihood of future income losses.
 - Explain clearly the costs of hazard-resistant construction practices so that households can plan their construction according to their budget.
- 3. Reduce perception that hazard-resistant construction practices are difficult to use or unsafe.**
 - Provide knowledge, skills and practical experience, both in disaster risk reduction programs in at-risk areas, and during reconstruction following a disaster through awareness-raising and training to help communities build their confidence in using disaster-resistant practices, and to reduce perception that practices are unsafe.



I do not like to use lime on the walls as it is very dangerous if children eat it.

Muhammad Hayat
Khan Bugti village,
Jacobabad, Pakistan





In Madagascar, users and non-users cited displacement from their homes as a severe consequence of losing their homes in a disaster.
Photo by Sara A. Fajardo for CRS

PERCEIVED SEVERITY

The results of the study indicate that *perceived severity* was not a significant determinant of disaster-affected households' behavior with regard to the adoption of the hazard-resistant construction practices recommended by CRS during the reconstruction process.

In four locations, users and non-users alike cited displacement from their homes (to emergency shelter, or to stay temporarily with family or friends) as a severe consequence of losing their homes in a disaster.

But in **India**, more users than non-users perceived losing livelihood assets kept at home (such as seed stock and domestic animals) as a severe consequence of their home being destroyed. This suggests that in some circumstances the association of the loss of a home with loss of livelihoods assets may influence people to adopt hazard-resistant practices when they reconstruct their home, rather than to focus exclusively on the loss of the home structure. Conversely, for those interviewed, the loss of household assets, or children falling sick, did not persuade people to use the practices.

PERCEIVED SEVERITY

How severe the consequences of the hazard event are perceived to be.

For example, some people may think that their home, along with its contents, is likely to be badly damaged in a future flood if they do not use any of the hazard-resistant construction practices.



RESULTS OF BARRIER ANALYSIS RELEVANT TO PERCEIVED SEVERITY

‘When your home was destroyed in flood/cyclone/typhoon, in what ways did that severely affect you and your family?’

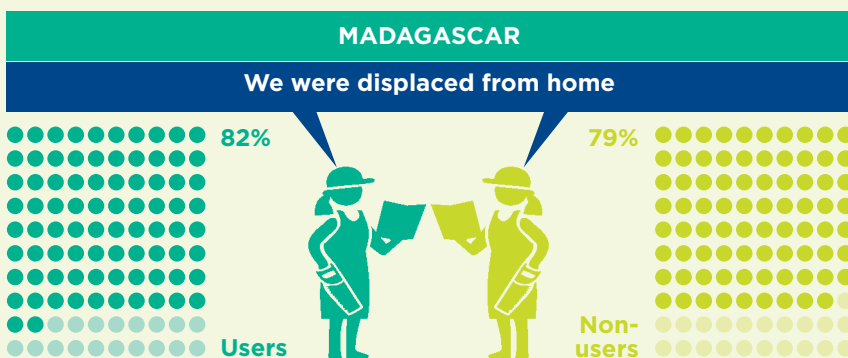
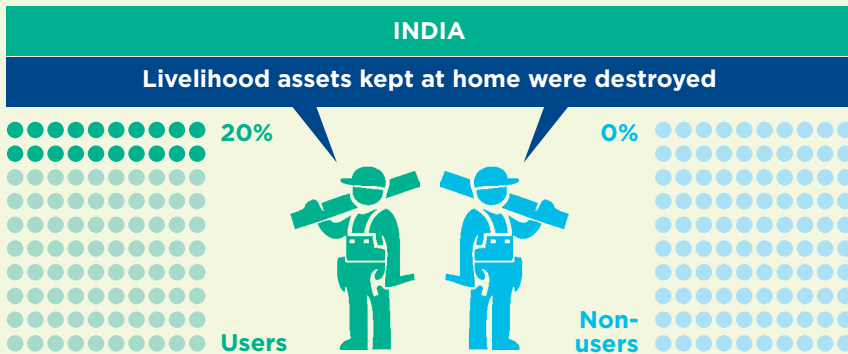
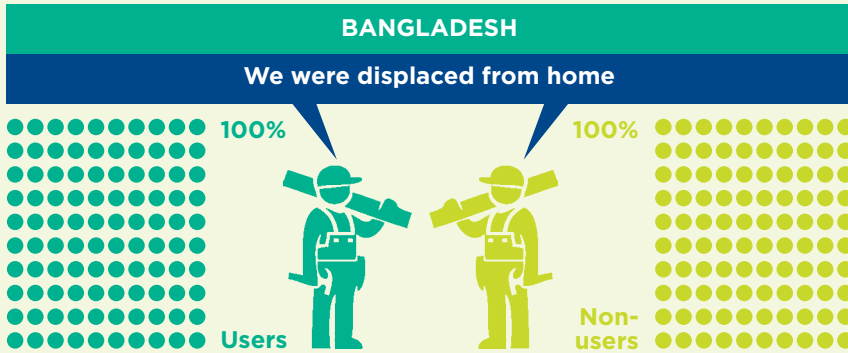

KEY

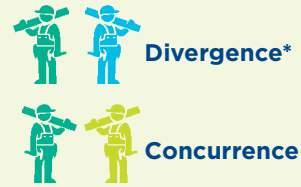

* Philippines More than 25%.
 India, Madagascar and Bangladesh More than 20%.
 Pakistan More than 15%.



The floods forced me to sell my livestock for very low prices to buy food and clothes as we had nothing left to eat or wear. We stayed on the canal banks for more than five weeks as we did not have money to rent a vehicle to take us to a safer place.

Abdul Karim
 Abid Ali Shah village,
 Jacobabad, Pakistan



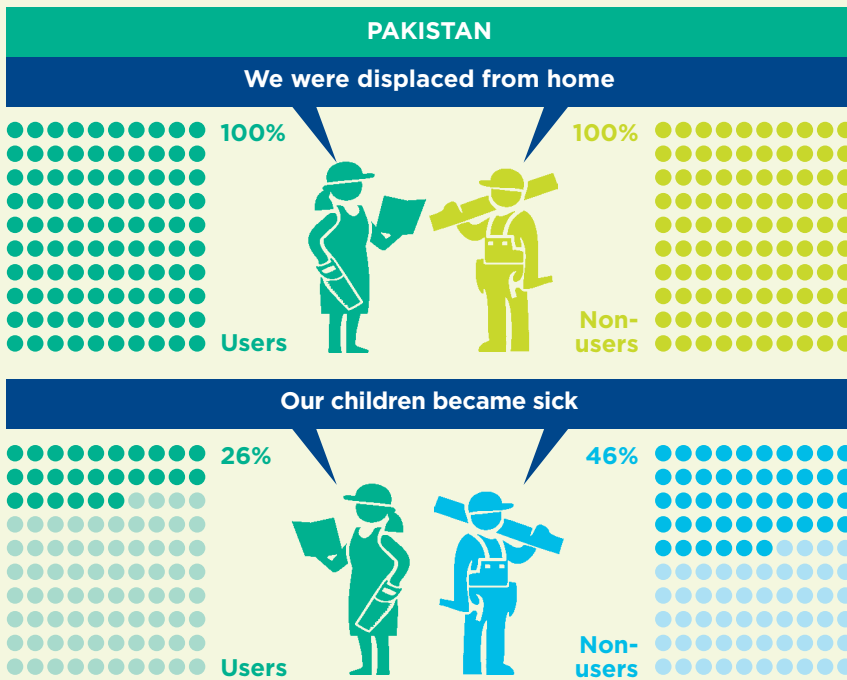

“

The floods completely destroyed my house and I lost my two goats who drowned. They were my family’s only source of income. We lost everything: paddy stock that was kept in the house got washed away, as did our clothes, furniture and utensils.

Purna Charan Marandi
Langaleswar village,
Balasore, India

”

SUGGESTED STRATEGIES AND ACTIVITIES TO INCREASE PERCEIVED SEVERITY

Although perception of severity may not be a significant barrier to the use of hazard-resistant construction practices within the locations of this study, it should still be identified and taken into account. Therefore, to increase the perception of severity, organizations such as CRS should consider the following:

Increase understanding among at-risk and disaster-affected households of the immediate impacts of different hazards, and how different hazard-resistant construction practices may help protect their homes and assets.

- Provide training to at-risk and disaster-affected communities on the present and projected impacts of climate change, including easy-to-understand, down-scaled data and information on how the intensity and frequency of relevant hazards is likely to be affected.
- In disaster-affected communities, use popular media, visual aids and IEC materials to demonstrate why homes that were constructed using inadequate practices were destroyed and the impacts on health, livelihoods and longer-term prosperity.
- Provide disaster-affected and at-risk communities with examples of how much it costs to replace household and livelihood assets, compared to the cost of protecting their assets, and how this negatively affects the longer-term prosperity and well-being of families.



Almas Sikdar works to create his “dream house” that is resilient to cyclones in Moddo Chaltabunia village in southern Bangladesh. Photo by Jennifer Hardy for CRS

PERCEIVED ACTION EFFICACY

The results of this study indicate that *perceived action efficacy* was not a significant determinant of disaster-affected households’ behavior with regard to the adoption of the hazard-resistant construction practices recommended by CRS during the reconstruction process.

In all locations of the study, users and non-users expressed a relatively high level of confidence in the effectiveness of the practices recommended by CRS to withstand the hazard(s) for which they were designed.

PERCEIVED ACTION EFFICACY

Whether people think the hazard-resistant construction practices are **effective**. For example, some people may believe that using roof ties will prevent their roof from being lifted in a typhoon, while others may regard the practice as useless.



RESULTS OF BARRIER ANALYSIS RELEVANT TO PERCEIVED ACTION EFFICACY
 'Is a house built using the hazard-resistant practices recommended by CRS likely or unlikely to withstand a flood/cyclone/typhoon?'

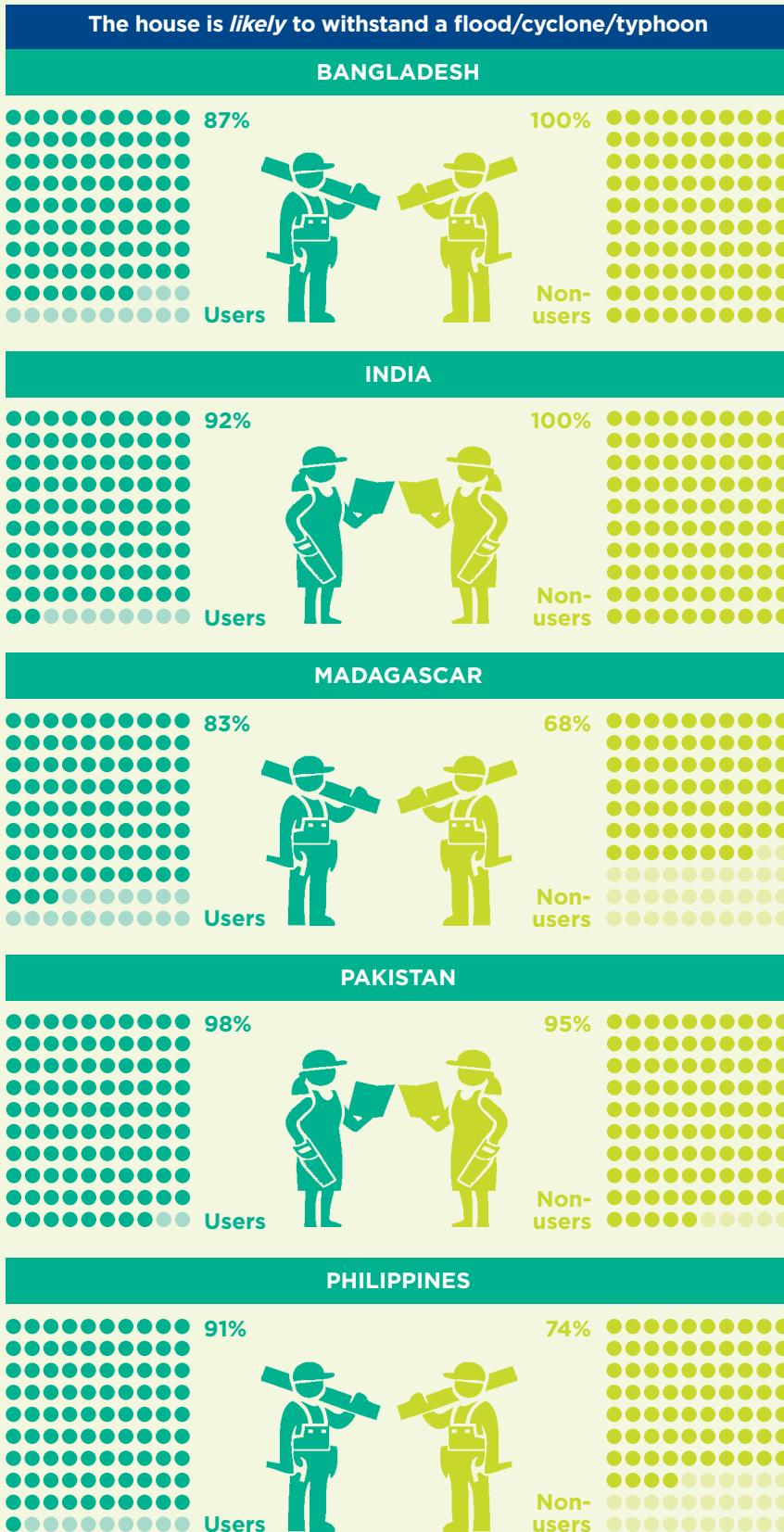

KEY

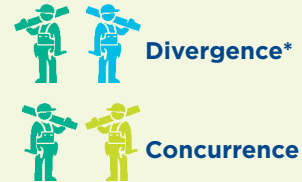

* Philippines More than 25%.
 India, Madagascar and Bangladesh More than 20%.
 Pakistan More than 15%.



After the flood, I saw that CRS was providing housing support to flood-affected people in another village. I saw that people were constructing their houses differently and using raised plinths and fixing the columns in earth. These practices were new to me but seemed a good idea to protect the house from flooding. I got in touch with the housing construction team and learnt more about these housing construction practices.

Abdul Karim
 Abid Ali Shah village,
 Jacobabad, Pakistan



SUGGESTED STRATEGIES AND ACTIVITIES TO REINFORCE PERCEIVED ACTION EFFICACY

Although perception of action efficacy may not be a significant barrier to the use of hazard-resistant construction practices within the locations of this study, it is important to recognize that raising people's awareness of how to make their homes more resistant to hazards is not only ethical, it also lays the foundation of knowledge upon which other determinants, such as cues for action, may act. Therefore, to reinforce the perception of action efficacy, organizations such as CRS should consider the following:

- 1. Develop improved hazard-resistant construction practices based on local knowledge of local and traditional hazard-resistant construction practices proven to be effective in previous disasters.**
 - As a disaster preparedness activity in program areas, conduct a technical assessment of common construction practices and their effectiveness in terms of hazard resistance.
 - Consult both men and women on their perceptions of the pros and cons of common construction practices, and their perceptions of the effectiveness of these to resist common hazards.
 - Ensure that, if local and traditional practices are ineffective, alternative technical solutions go hand in-hand with training for skilled laborers and local community members on their benefits, as well as how to use them.
- 2. Communicate the relative effectiveness of different practices in ways that are readily understood by different communities.**
 - Hold awareness raising/training sessions with communities and skilled laborers to demonstrate the effectiveness of common and alternative hazard-resistant construction practices.
 - Design appropriate messaging for IEC materials and wider 'build back safer' campaigns based on the above interactions with community members and skilled laborers.

“

Now our house and family will be safe in case of future flooding because we built our house on a raised plinth and also kept a slope on the veranda roof. After adopting these practices I think we will not be sustaining any loss or incurring additional expenses on construction of the house again and again. So it will save money.

Peer Bux

Gulzar Kehar village,
Jacobabad, Pakistan

”



Photo by Tasleem Begum

Muhammad Lashari used his limited resources to try and replicate hazard-resistant construction practices.

CASE STUDY: PAKISTAN

I TRIED TO COPY THE CRS STRUCTURE AS MUCH AS POSSIBLE

Muhammad Lashari, 40, lives in Saeed Ahmed Khoso village in Union Council Kot Jhango. He has five children.

“The 2010 flood destroyed everything around us. My house was destroyed, and I lost all my crops and the food I had stored in the house. Most of my animals died and the few that remained I sold to feed my family and because fodder was not available. In 2012 it flooded again. We lost our house and our crops. We lived on the elevated roadside until the water receded.

“CRS started building shelters nearby and my brother started working as skilled labor with CRS. I saw some of these shelters and consulted with my brother to build the same structure for my family because this shelter is much safer in case of flooding. I arranged 15,000 rupees and bought the required items from the local market. Considering the importance of the raised plinth I selected a place which was already higher than the surrounding ground. Then I asked to my brother for his support to do the construction work. Though I have limited resources and could not buy all of shelter material I tried to copy the structure as much as possible.”



Khazadi, 28, prepares food near the Jamali Bypass highway in Jacobabad, Sindh province, Pakistan, where she took refuge after floods. In Pakistan, users and non-users did not identify any customs that might prevent people from using the hazard-resistant practices. Photo by Asad Zaidi for CRS

CULTURE

The results of the study indicate that *culture* was not a significant determinant of disaster-affected households' adoption of the hazard-resistant construction practices recommended by CRS and its partners.

In all locations included in the study, there was little or no difference between the answers of users and non-users on this determinant.

In four of the five locations, users and non-users did not identify any customs that might prevent people from using the hazard-resistant practices recommended by CRS.

In **Madagascar**, users and non-users alike said they had followed a local custom that they believed would protect them from misfortune. The custom involves inviting traditional leaders to the place where the home will be built to conduct a ceremony 'to evoke the good spirits of the ancestors'. It also requires the host to invite his or her neighbors to the ceremony, and to provide refreshments for all present.

According to the results of the study, this custom was not a barrier to the adoption of the hazard-resistant practices recommended by CRS in Madagascar, but it does suggest that some households are willing to spend scarce resources on measures they feel will keep them safe from misfortune. This knowledge is relevant for organizations interested in developing locally relevant strategies to promote hazard-resistant construction practices.

CULTURE

Whether culture (such as **history, customs, lifestyle, values, practices**) within a self-defined group influences the ways in which people construct their homes. Culture may be associated with ethnicity or lifestyle and often influences an individual's perceived social norms.



RESULTS OF BARRIER ANALYSIS RELEVANT TO CULTURE

‘Do you know of any customs that might prevent people from using the hazard-resistant practices promoted by CRS? If so, what are they?’

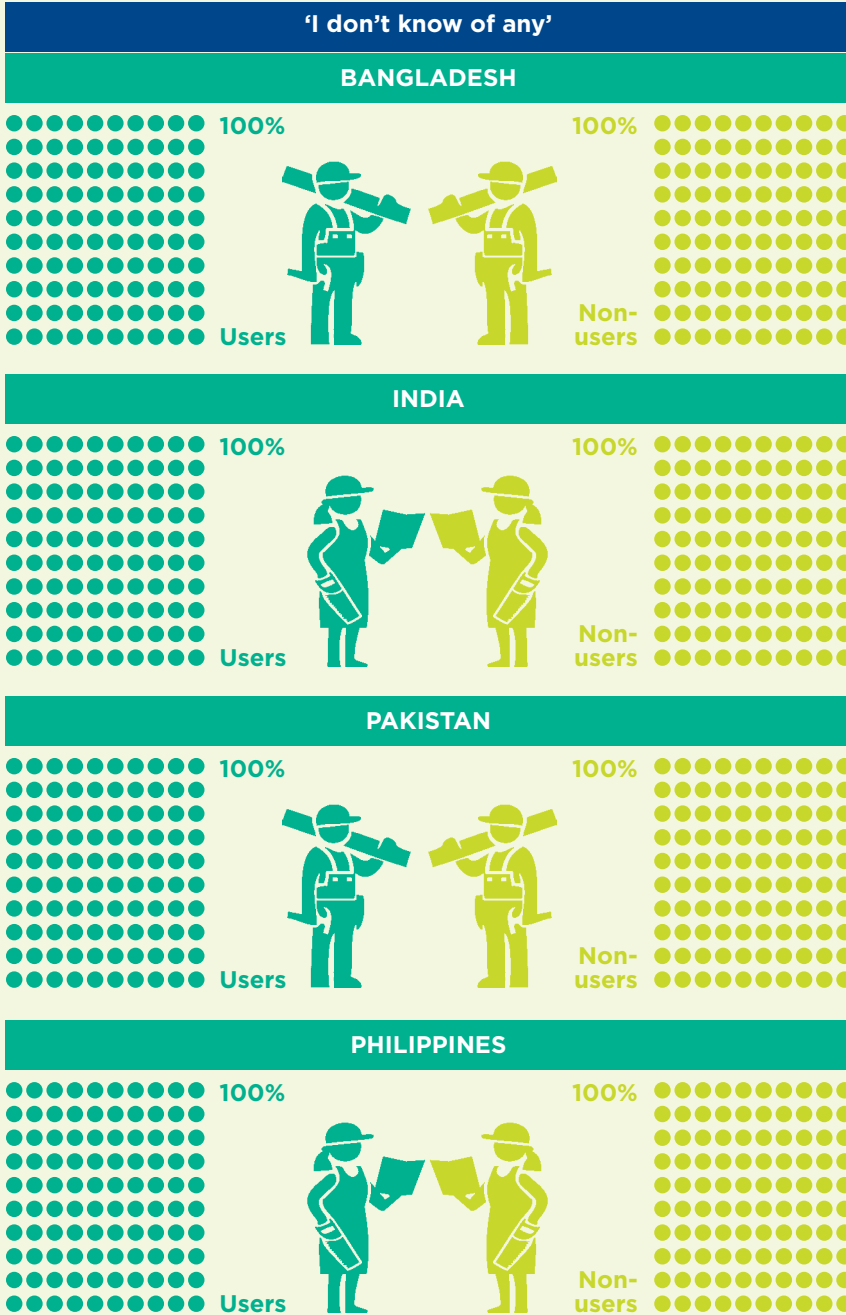

KEY

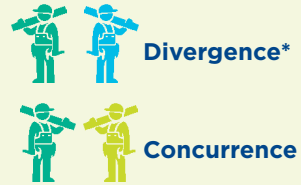

* Philippines More than 25%.
 India, Madagascar and Bangladesh More than 20%.
 Pakistan More than 15%.



When we start to build a home, we invite the traditional leaders to the site where we want to build and offer them drinks and food. Our neighbors come too, to hear the traditional leaders call on the spirits of our ancestors and to have some refreshments. If the ancestors tell the traditional leaders that they give us their blessing, then we can start to build.

Fred Florent Sambandahy
 Brickaville, Madagascar



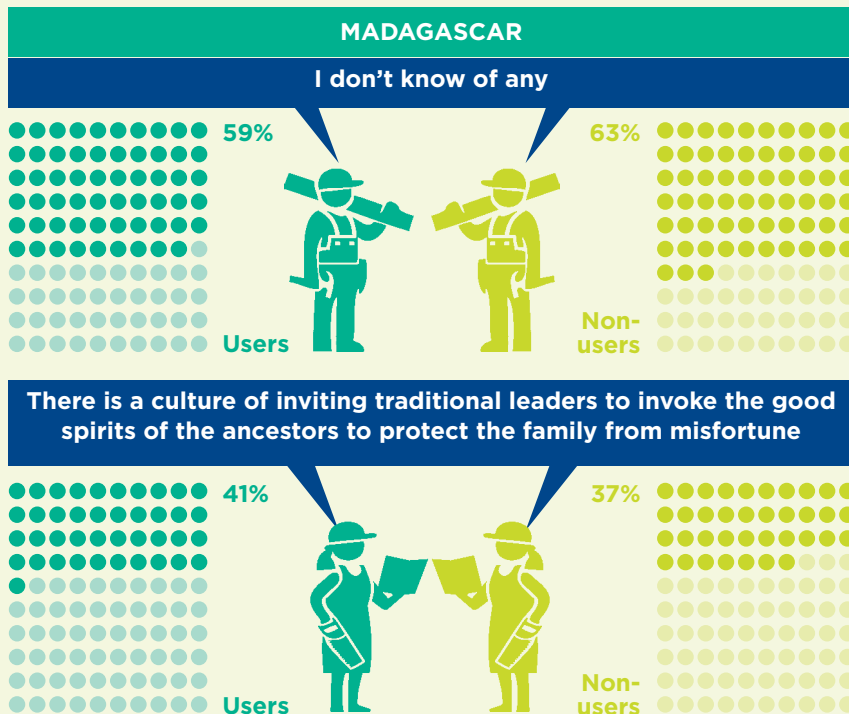

SUGGESTED STRATEGIES AND ACTIVITIES TO REINFORCE CULTURALLY APPROPRIATE BEHAVIORS THAT SUPPORT THE USE OF HAZARD-RESISTANT CONSTRUCTION PRACTICES

To reinforce culturally appropriate behaviors that promote the use of hazard-resistant practices, and to address other relevant cultural factors, organizations such as CRS should consider the following:

- 1. Ensure effective consultation about cultural aspects of construction.**
 - Design post-disaster and pre-project assessments to include consultation on local customs and cultural practices with women, men, older people and minority groups in communities where reconstruction or retrofitting programs are proposed.
- 2. Listen to, and address, concerns related to culture.**
 - Establish user-friendly monitoring and feedback mechanisms to encourage people to voice their concerns about any cultural issues related to hazard-resistant construction.
 - Where possible, adapt recommended practices to take into account cultural concerns.



Across all study locations, users and non-users alike perceived that their neighbors approved of the hazard-resistant construction practices. Here a woman stands outside her house in Brickaville, Madagascar. Photo by Susan Walters for CRS

PERCEIVED SOCIAL NORMS

The results of the study indicate that *perceived social norms* was not a significant determinant of disaster-affected households' behavior with regard to the adoption of the hazard-resistant construction practices recommended by C

RS during the reconstruction process.

Across all locations of the study, users and non-users alike perceived that their neighbors approved of the practices and, in four locations, both groups mentioned that family members agreed with the use of practices. In **Madagascar**, a small number of users mentioned that CRS staff and skilled laborers also approved.

In all of the locations the vast majority of users and non-users of the practices were unaware of anyone they knew who disapproved of the practices. A very small number of respondents from both groups mentioned people they knew who did not approve of certain aspects of the practices, such as older community members in **Bangladesh** who did not think the plinths were high enough, and family members in the **Philippines** who thought that the tie-wires were ineffective, or that raised floors were unsafe for children.

PERCEIVED SOCIAL NORMS

Whether people think they will get

approval or **disapproval** from family, friends, neighbors and others around them for using the hazard-resistant construction practices. For example, some people may think that their parents will regard digging deeper foundations as a waste of time, while others may think that their neighbors will approve of it.



RESULTS OF BARRIER ANALYSIS RELEVANT TO PERCEIVED SOCIAL NORMS

'Of the people you know, who approves/doesn't approve of the use of these practices?'

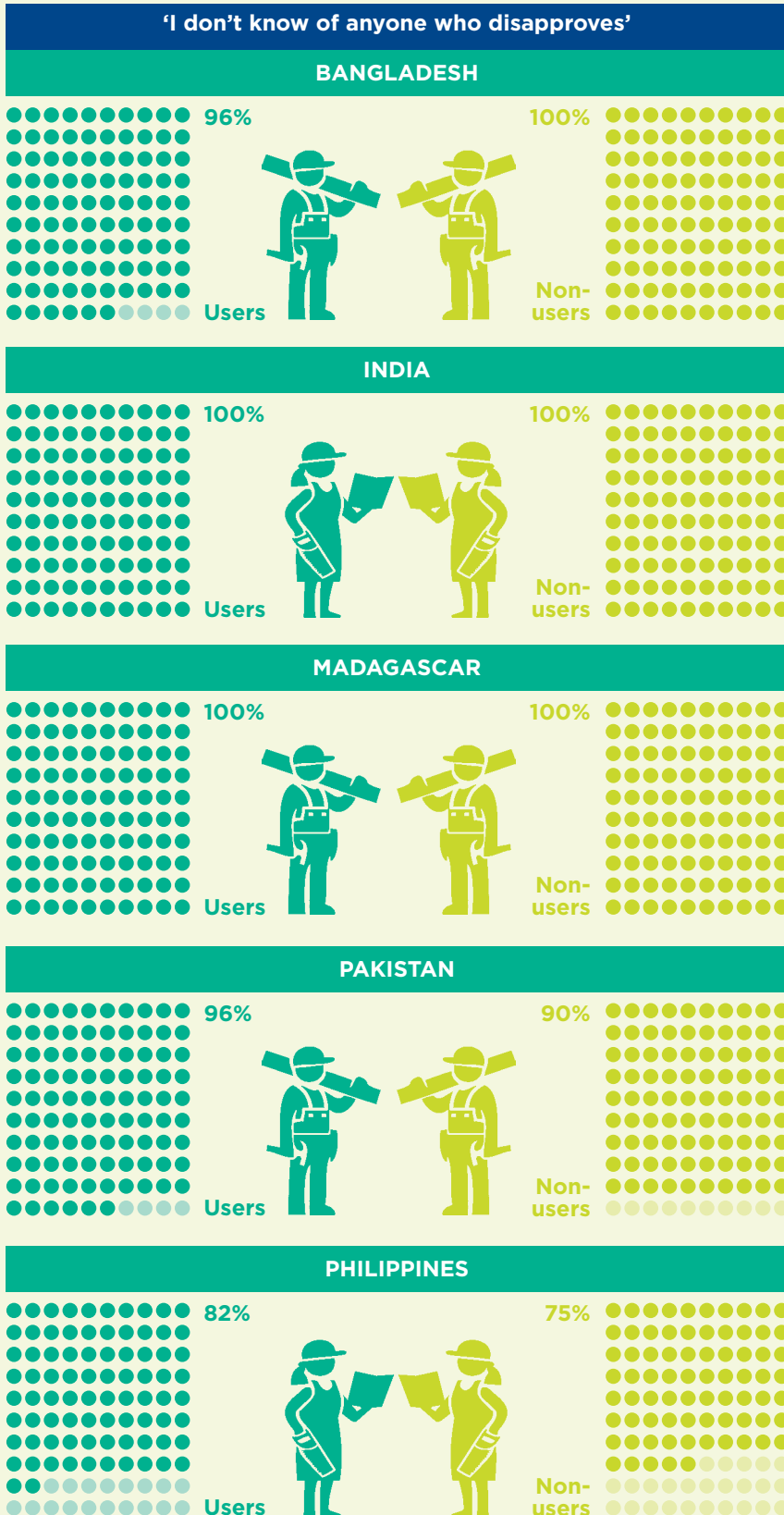

KEY

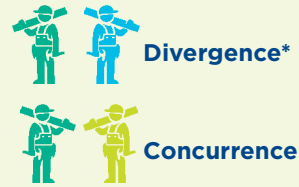

* Philippines More than 25%.
 India, Madagascar and Bangladesh More than 20%.
 Pakistan More than 15%.



Some elderly people in the village think that the plinths are not high enough; that they need to be higher than the [embankment] road to cope with future flooding.

Alamin Sardar
 Sora-9 village, Satkhira,
 Bangladesh



SUGGESTED STRATEGIES AND ACTIVITIES TO REINFORCE PERCEPTION OF SOCIAL APPROVAL

To encourage and reinforce perceptions of approval by family, friends, neighbors and others for using the hazard-resistant construction practices, organizations such as CRS should consider the following:

- 1. Continue to use participatory processes to select and adapt the hazard-resistant practices that will be used in programs and recommended to other disaster-affected households.**
 - Hold focus group discussions with different social groups during the project design phase, to identify which of the practices might not gain their approval and use this information when considering which practices to promote.
 - Use beneficiary feedback mechanisms in reconstruction projects, so that any issues of disapproval or opposition are identified and addressed as soon as possible.
 - Work closely with communities, local and national government, and other organizations that may be offering different solutions to other nearby communities, to address any issues.
- 2. Provide ways in which communities can publicly display their approval for hazard-resistant practices.**
 - Create opportunities for public displays of approval by neighbors and friends, such as ceremonies to celebrate the completion of construction of demonstration homes and family homes, and determine the value of these events for potential replication and scale-up.



“Don’t make that mistake again,” Jules Lekamisy tells his neighbors, referring to non-hazard-resistant building techniques.

CASE STUDY: MADAGASCAR ‘THERE’S NO POINT BUILDING HOUSES LIKE THOSE WE HAD BEFORE’

Jules Lekamisy, 51, has lived all his life in the small hamlet of Namahoaka. He and his wife, Cynthia, have three sons and a daughter. They grow rice to eat and lychees to sell. Their house was destroyed by Cyclone Giovanna.

“All our rice and lychee crops were destroyed. And the chickens that we kept under our house were killed,” says Jules.

It took him and his family over two years to save up enough money to buy the materials and then another month to rebuild the house themselves. “We copied a house that was being built by CRS for our neighbor as we could see it was stronger than the others around us.”

Their new house has cross-bracing on the roof and metal ties attaching the roof structure to the corner posts. “I couldn’t use all the practices I wanted as I couldn’t afford the rest of the materials but I hope to keep improving it when I can”, says Jules.

“Our new home is stronger and my wife and children are happy about that. I tell my neighbors that there is no point constructing houses like the one we had before. Don’t make that mistake again, I tell them.”



In the Philippines, non-users were more likely than users to suggest that cyclones were 'a punishment from God'. Photo by Charlie David Martinez for CRS

PERCEIVED DIVINE WILL

The results of the study indicate that *perceived divine will* was not a significant determinant of the behavior of disaster-affected households' adoption of the hazard-resistant construction practices recommended by CRS and its partners.

In four of the five locations of the study, users and non-users did not mention 'divine will' or 'God's will' as a possible cause of the disaster or the destruction of their homes. The majority of both groups explained that the hazard that triggered the disaster was 'a natural phenomenon', and some attributed its unusual intensity or location to human activity, such as deforestation, and climate change. In some cases, people gave multiple explanations, indicating that they understood that disasters were the result of the interaction of several factors.

In the **Philippines**, users of the typhoon-resistant practices also tended to believe that a hazard (Typhoon Bopha) was caused by a natural phenomenon or excessive deforestation. However, non-users were more likely than users to suggest that the cyclone was 'a punishment from God'. This belief appears to have been a barrier to the use of the hazard-resistant practices recommended by CRS in the Philippines.

PERCEIVED DIVINE WILL

Whether people believe their lives are influenced by

supernatural forces or religion.

For example, some people may believe that an earthquake is a punishment from God.



RESULTS OF BARRIER ANALYSIS RELEVANT TO PERCEIVED DIVINE WILL
 'What do you think causes floods/cyclones/typhoons to occur?'

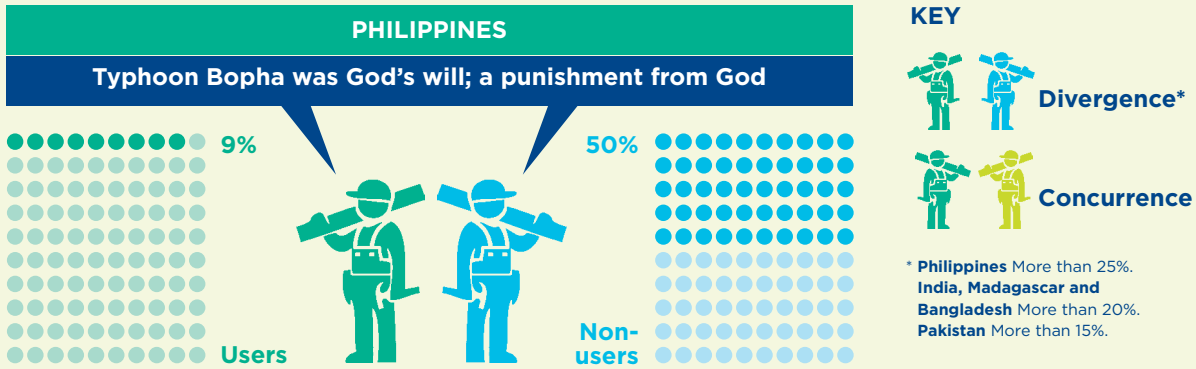

SUGGESTED STRATEGIES AND ACTIVITIES TO MAKE RESILIENCE BUILDING COMPATIBLE WITH BELIEF SYSTEMS

Although religious and supernatural beliefs may not be a significant barrier to scaling up the use of hazard-resistant construction practices in most locations, they should be identified and taken into account when designing resilience-building programs.

To increase the compatibility of efforts to construct hazard-resistant housing with local belief systems, organizations such as CRS could consider the following strategies and activities:

Engage religious leaders in program planning, to discuss and potentially reduce any perceived contradictions between religious and supernatural beliefs and technical approaches to risk reduction.

- Demonstrate hazard-resistant construction practices at places of spiritual importance. For example, improving the roof bracing of a church that also serves as a refuge in typhoons could provide a visual reminder of risk reduction practices and encourage those who attend the church to replicate them.
- Encourage religious leaders to promote hazard-resistant construction practices at ceremonies, during visits, and during other interactions with families.
- Discuss any contentious imagery associated with hazard-resistant practices.



I heard that Typhoon Bopha was going somewhere else but it changed course at the last minute and hit this area. It must have been God's will.

Liza Mesa
 San Miguel,
 Compostela Valley,
 Philippines





In all five locations, enforcement and public awareness of construction codes was low. Photo by Jennifer Hardy for CRS

POLICY

The results of the study indicate that *policy* was not a significant determinant of the behavior of disaster-affected households' adoption of the hazard-resistant construction practices recommended by CRS and its partners.

In all the locations of the study, users and non-users of the hazard-resistant construction practices recommended by CRS were unaware of any relevant laws or regulations that governed how their homes were built.

It is important to recognize that building codes exist in all of the countries in which this study was carried out. Evidently, however, in all five locations, enforcement and public awareness of the codes was low at least in the areas specific to the CRS projects and the study. Issues related to some types of policies were mentioned by a small number of respondents during the study, thus indicating an awareness of rules that might affect their housing situation but not necessarily the way in which their homes are constructed.

In the **Philippines**, some users demonstrated awareness of local zoning regulations designed to prevent settlements in flood-prone areas. This suggests that some regulations have been effectively communicated while others may not have had wide-scale visibility. In **Madagascar**, some users explained that families that intended to construct or reconstruct their homes needed to get permission from the village (*fokontan*) leader before they started.

In **Pakistan** and the **Philippines**, some non-users mentioned a requirement to consult landlords prior to reconstruction, and, in the Philippines, possible rent increases were associated with more 'permanent' structures. This highlights the need for further research into the factors that influence the behavior of tenants, particularly as the correlation between land tenure and the use of the hazard-resistant practices differed greatly across the five locations.

POLICY
Whether **laws**
or **regulations**
(including
informal ones)



influence the ways in which people construct their homes. For example, some people may be aware of a bylaw governing how roof trusses must be constructed to resist wind load, while others may not be aware of any policies that could govern how they construct homes.

RESULTS OF BARRIER ANALYSIS RELEVANT TO POLICY

'Are there any policies, laws or rules about how to reconstruct houses in this area?
If so, did any of these affect how you constructed your house?'

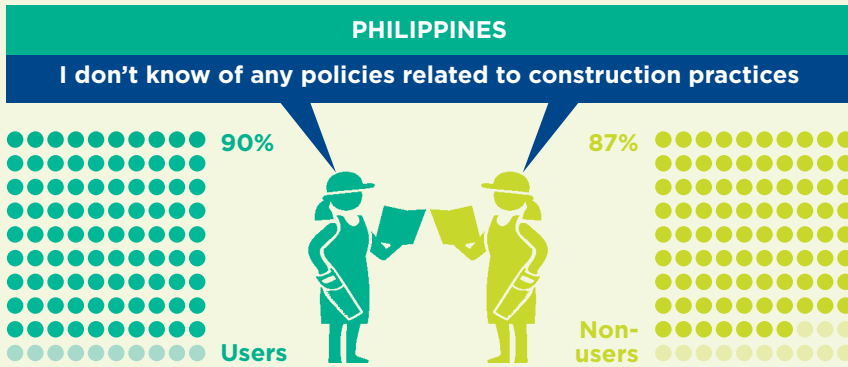
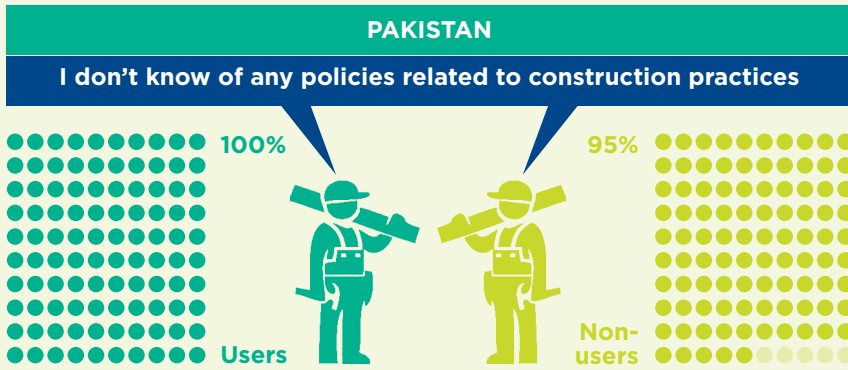
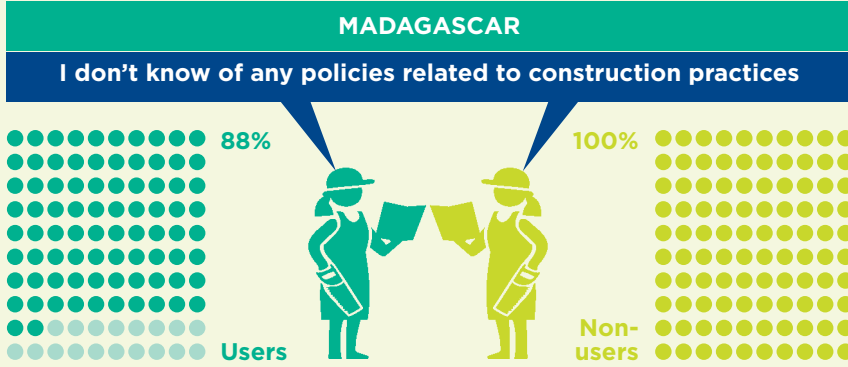

KEY

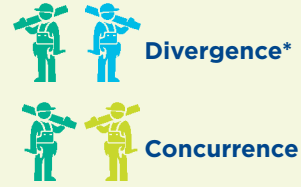

* Philippines More than 25%.
India, Madagascar and Bangladesh More than 20%.
Pakistan More than 15%.

SUGGESTED STRATEGIES AND ACTIVITIES FOR INCREASING THE EFFECTIVENESS OF POLICIES TO PROMOTE THE USE OF HAZARD-RESISTANT CONSTRUCTION PRACTICES

To reduce the likelihood of policy-related barriers to the adoption of hazard-resistant construction practices, organizations such as CRS should consider the following:

- 1. Identify and analyze the formal and informal policies affecting different sectors of the target population, and design programs that are responsive to these.**
 - As a disaster preparedness measure, or following a disaster, coordinate with other organizations interested in reconstruction/ construction to conduct a joint study of national building codes and standards to be informed of what policies exist and those that may not be systematically enforced.
- 2. Support governments in the development and dissemination of policies relating to hazard-resistant construction practices.**
 - Advocate for the incorporation of hazard-resistant construction practices in public buildings (schools, hospitals, etc.).
 - Establish a permanent or post-disaster coordination mechanism with national and local governments' housing/infrastructure departments.
 - Conduct interviews on the construction process with families that have recently built a home, to identify issues associated with permission and restrictions. Based on this knowledge, engage key authorities and individuals that play a role in granting formal or informal construction permits, and raise their awareness of hazard-resistant practices and standards.
- 3. Encourage households to construct using hazard-resistant practices.**
 - Produce IEC materials that specify how recommended hazard-resistant practices comply with national building standards.
 - Fund and manage elements of campaigns to improve implementation of building codes, with a particular focus on reaching poor, at-risk and marginalized communities.
- 4. Identify and analyze the formal and informal policies affecting different sectors of the target communities, and design programs that are responsive to these.**
 - As a disaster preparedness measure, conduct research on land tenure, tenancy and construction/reconstruction, to inform potential reconstruction programs and advocacy.



If we wanted to build a stronger house we would have to ask the landlord's permission. He would say 'yes' but then he would charge us a higher rent.

Angelita Amas
Mangayon village,
Compostela Valley,
Philippines





Henry and Helen Manlawi found it difficult to use the hazard-resistant techniques because of multiple demands on their resources immediately after the typhoon. They plan to incorporate the techniques gradually. Photo by Susan Connolly for CRS

UNIVERSAL MOTIVATORS

The results of this study indicate that in all five locations, having enough food to feed their family was among the three most commonly cited motivations by users and non-users. Other motivations most commonly mentioned by participants were: creating a better future for their children, living in a better home, and having a strong livelihood.

Despite these similarities, in each location the three most commonly cited motivations differed somewhat. In **Pakistan** and the **Philippines**, a large proportion of users and non-users said they were motivated to own their own land, crops, livestock or business, while in **Bangladesh** and **Madagascar** users and non-users mentioned their family's health among their key motivations.

Some motivations were also more commonly cited by users than non-users, and vice versa; for example, in **India**, more non-users than users were motivated by creating a better future for their children, while more users than non-users were motivated by a better livelihood.

These similarities and differences offer opportunities to engage specific communities in initiatives to increase adoption of hazard-resistant construction practices. By linking strategies to promote the practices with incentives related to the common motivations of a given group, organizations such as CRS may be able to influence more people to use the construction practices that will help them achieve multiple goals.

UNIVERSAL MOTIVATORS

While not considered a determinant, universal motivators are **factors that motivate most people**, irrespective of other variables. For example, most people want their family to have enough food to eat, and this will influence their behavior.



RESULTS OF BARRIER ANALYSIS RELEVANT TO UNIVERSAL MOTIVATORS
 'What are the things that you want most in life?'

BANGLADESH



INDIA

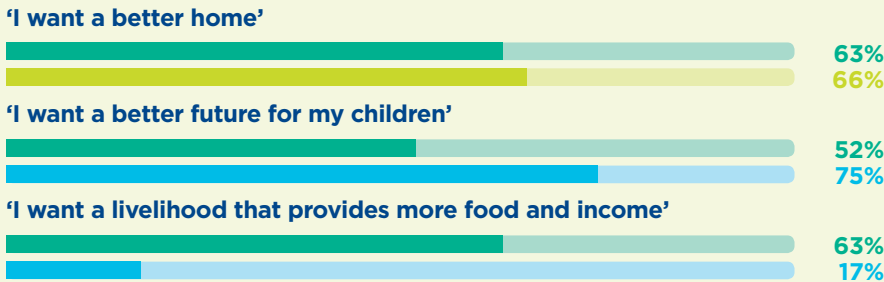

MADAGASCAR

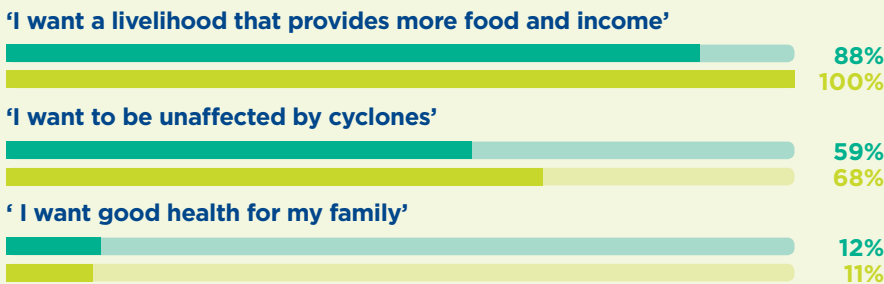

PAKISTAN

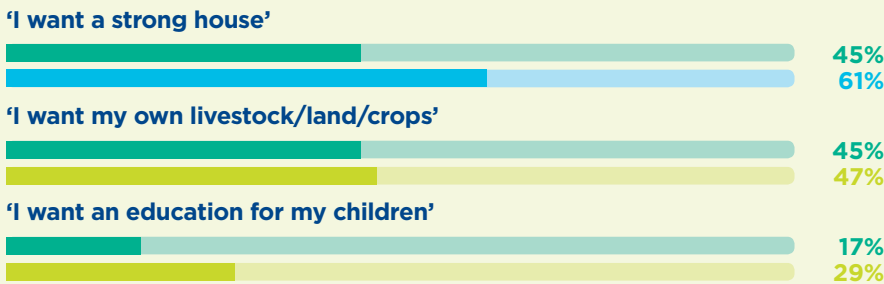

PHILIPPINES

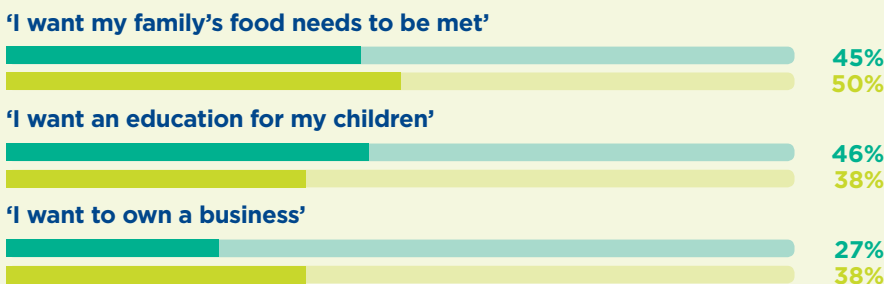

KEY

DIVERGENCE*

- Users
- Non-users

CONCURRENCE

- Users
- Non-users

* Philippines More than 25%.
 India, Madagascar and Bangladesh More than 20%.
 Pakistan More than 15%.



Someday I'd like to live in a better home but for now our priority is to get food on the table and finish paying for our children's education.

Angelita Amas
 Mangayon village,
 Compostela Valley,
 Philippines



SUGGESTED STRATEGIES AND ACTIVITIES TO LINK UNIVERSAL MOTIVATORS WITH OTHER DETERMINANTS OF BEHAVIOR

To maximize the role of relevant universal motivators in supporting the adoption of hazard-resistant construction practices, organizations such as CRS should consider the following:

- 1. Increase at-risk and disaster-affected households' understanding of the linkages between hazard-resistant construction practices and the benefits related to different universal motivators such as improved food security and livelihoods, a safe home, and reduced risk of disaster.**
 - Provide information and/or carry out awareness-raising campaigns on how adopting hazard-resistant construction practices results in 'a safer home' or 'a better future' for children, or 'improved food security' etc.
- 2. Integrate hazard-resistant construction practices into long-term development programs (for example, food security, livelihoods, DRR) to increase understanding of the linkages between increased investment in a safer home and general well-being and good development.**
 - Choose strategies and practices that are context-appropriate based on the likelihood of different hazards and their severity, household vulnerability and capacity.
 - Design and implement livelihoods programs that develop local value chains and improve access to markets for local products accompanied by **(a)** communications strategies that show how avoiding repeated expenditure on reconstructing after disasters enables households to invest in improving their livelihoods, and **(b)** initiatives to encourage investment of increased earnings in disaster resistant housing.
 - Liaise with local planning authorities to ensure hazard-resistant construction practices are promoted in at risk communities.



I needed to get a roof over our heads and go out to earn money so we could eat and the children could finish their schooling. In the future, when we can afford it, I'll make some changes to our house so it is more resistant to typhoons.

Henry Manlawi
San Miguel village,
Compostela Valley,
Philippines



Photo by CRS staff

Afsar Howladar and his wife lived on an embankment for three years before they were able to build a new home, using hazard-resistant techniques.

CASE STUDY: BANGLADESH 'FEELING SAFER IN OUR NEW HOME'

Afsar Howladar, 60, lives with his family in the coastal village of Jelekhali in Satkhira district. He and his wife live with their three sons, two daughters-in-law, and two grandsons. They earn a living from fish farming.

"When the cyclone hit and the high tide came, everything flooded. My son helped us all get to an embankment, but not without injury." They saw their house and kitchen washed away along with their neighbors' houses, all within 30 minutes.

"The cyclone not only took our home and our belongings, it also took our livelihood. The fish farm was destroyed and we struggled to survive. For three years we were forced to live on the embankment. Now we have a new home, thanks to a loan from the local cooperative credit union," says Afsar. "We used what we learned from the Caritas program to build a stronger home. We preserve dry food, check the structure of the house, and regularly maintain the plinth. Now my family feel very safe in our new house."

Conclusion and recommendations

The study found that five determinants of behavior significantly influenced the adoption of the hazard-resistant construction practices recommended by CRS and its partners by disaster-affected households that were not beneficiaries of their reconstruction programs. *Cues for action* was most significant, followed by *access*, *perceived risk* and *perceived positive consequences* and *perceived self efficacy*.

RELATIVE SIGNIFICANCE OF DETERMINANTS OF BEHAVIOR FOR ADOPTION OF HAZARD-RESISTANT PRACTICES RECOMMENDED BY CRS

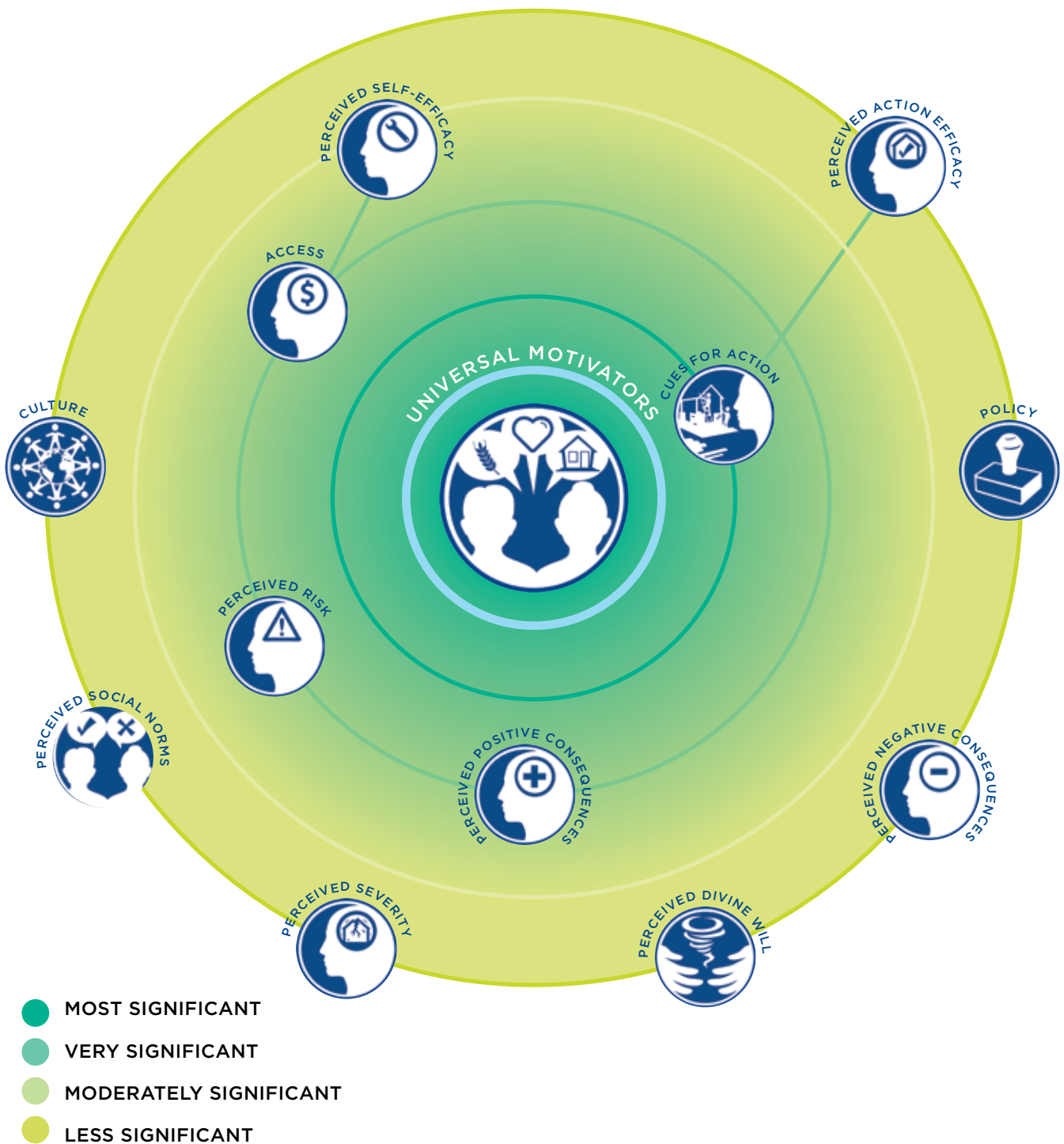

Cues for action was the most significant of these determinants of disaster-affected households' behavior. The demonstration homes constructed to show the use of the hazard-resistant practices were more effective than any other deliberate actions undertaken by CRS to influence the choices of non-beneficiaries during reconstruction. Observing at close hand the construction of CRS beneficiaries' homes also prompted many non-beneficiaries to adopt the practices. Based on this knowledge, **organizations such as CRS should maximize the 'cue' value of demonstration homes and beneficiaries' homes by increasing direct contact with them and the skilled laborers working in them. Instead of seeing homes only as program outputs, organizations should use them as multipliers/leverage points for extending impact beyond direct program beneficiaries.**

Access to the materials and skilled labor required to construct a home using hazard-resistant construction practices was also shown to be a significant determinant of disaster-affected households' behavior. A lack of resources to use the practices was a barrier for many families beyond the direct beneficiaries, particularly for single-headed households and those with subsistence livelihoods. **To overcome this barrier, organizations such as CRS should ensure that the hazard-resistant practices they promote are easier to access, financially (access to money via savings, cash-for-work, livelihoods or other means) and physically (access to materials and skilled labor). This requires a conscious departure from the concept of providing a small proportion of disaster-affected families with a new home while others, who may be similarly poor and vulnerable, do not receive any support to help them 'build back safer'.**

Perceived risk also proved to be a significant determinant of disaster-affected households' behavior. When people felt that their community would be affected by another cyclone or flood in the near future and recognized that the way their home was constructed made them more vulnerable, they took action to construct a safer home. Just recognizing that another hazard was likely to occur was not enough to prompt them to change their construction practices. **To foster an accurate perception of risk at the household level, organizations such as CRS need to ensure that people understand the components of risk, and that the type of construction practices they choose directly affect whether or not their home will withstand a hazard event. This requires a greater investment in information and education than is normally made in reconstruction programs, as well as the inclusion of the promotion of safe housing (with resilient livelihoods and community organization) in long-term DRR programs.**

Perceived positive consequences was also shown to be a significant determinant of disaster-affected households' behavior. People who directly associated the construction practices with preventing damage to their home during hazard events and increasing their home's overall stability and durability were more likely to adopt them than those who were unaware or unconvinced of such benefits. **To scale up adoption of hazard-resistant construction practices, organizations such as CRS should ensure that people understand their advantages in severe climatic conditions and the everyday and**

.....

The demonstration homes constructed to show the use of the hazard-resistant practices were more effective than any other deliberate actions undertaken by CRS to influence the choices of non-beneficiaries during reconstruction.

.....



Photo by CRS staff

long-term benefits of using them. This requires investing more time in helping them understand which aspects of their home are most important to each target group and creating a communications strategy that relates the recommended practices to them.

Perceived self-efficacy was shown to be a moderately significant determinant of behavior, although its direct relationship with access and interlinkages with other determinants makes it difficult to ascertain its relative importance. People were prevented from using the practices when they felt they lacked the necessary skills and knowledge and were unable to pay a carpenter or mason to use them. **To overcome this complex barrier, organizations such as CRS should make program design choices based on knowledge of the relevant skill sets of the target population, the extent to which skills need to increase for people to feel confident to carry out the practices, and the capacity of different sectors of the target population to pay for skilled labor.**

The determinants that were shown to be less significant in this study are *perceived severity*, *perceived divine will*, *perceived negative consequences*, *perceived action efficacy*, *culture*, *perceived social norms* and *policy*. This does not mean, however, that programs to promote hazard-resistant housing should disregard them. Instead, **organizations such as CRS should ensure that their assessment process and monitoring systems enable them to make decisions based on knowledge of all common determinants of behavior, not assumptions about them.**

For example:

- *Perceived negative consequences* could result from an inadequate consultation process prior to the selection of the construction practices to be promoted.
- *Perceived severity* of the consequences of losing their home could vary among people with different forms of income generation, and *perceived action efficacy* could vary in areas of high immigration where some people may have had greater exposure to the use of hazard-resistant construction practices than others.
- *Culture* and *perceived social norms* played little part in people's choices of construction practices in most of the locations of this study perhaps due to the high level of local knowledge of CRS and partner staff, but this may be more challenging for organizations operating in areas of which they have limited prior knowledge or places where there is limited access.
- *Perceived divine will* did affect people's behavior in one location, which underscores the need for initial assessments to include analysis of beliefs.
- *Policy* was also shown to be of little or no significance with regard to the adoption of the hazard-resistant practices, mainly due to a lack of knowledge and weak implementation of national construction codes. However, **to promote sustainable and long-term disaster risk reduction, organizations such as CRS should contribute to efforts to make people living in at-risk areas aware of relevant aspects of hazard-resistant construction codes and policies, and to support efforts to implement them.**

The study found that *universal motivators* were, indeed, universal.

.....
People who directly associated the construction practices with preventing damage to their home during hazard events and increasing their home's overall stability and durability were more likely to adopt them than those who were unaware or unconvinced of such benefits.
.....



Photo by CRS staff

People were motivated by having their basic needs (safe home, food security, and good health) met, creating a better future for their children, and improved livelihoods. **Organizations such as CRS should identify what people in their program areas want most in life, and use this knowledge to create incentives for using hazard-resistant construction practices.** Disaster risk reduction efforts could gain greater traction when associated with other goals. For example, where most people are highly motivated to provide education for their children, organizations could develop communications strategies that explicitly relate the capacity to pay for education with the use of hazard-resistant practices that prevent damage to and loss of family homes.

Although it was outside the scope of the research, the study also highlighted the need for post-disaster housing reconstruction programs to correspond with affected peoples' own timeframes for reconstruction. **To better synchronize external inputs with local dynamics, organizations such as CRS need to substantially increase investment in disaster preparedness, so that locally relevant designs incorporating the practices, as well as materials, technical support and communications plans, can be mobilized at short notice.**

Overall, this study shows the need for a transformation in the way reconstruction programs are conceived and implemented if organizations such as CRS want to substantially increase their impact. Technical shelter experts need to collaborate with experts in social research methods, communications, food security and livelihoods, to ensure that programs take into account the multiple and inter-related determinants of people's behavior. The study also draws attention to the need and opportunities to promote hazard-resistant construction through longer-term disaster risk reduction programs, rather than waiting until a hazard event occurs.

.....
This study shows the need for a transformation in the way reconstruction programs are conceived and implemented if organizations such as CRS want to substantially increase their impact.
.....

Catholic Relief Services
228 West Lexington Street
Baltimore, Maryland 21201-3443
1.888.277.7575
www.crs.org

